

# GH**OST**BUSTERS™

ECTO-1



**Wreabbit** 3D™  
PUZZLE

*Assembly Instructions  
Instructions d'assemblage*



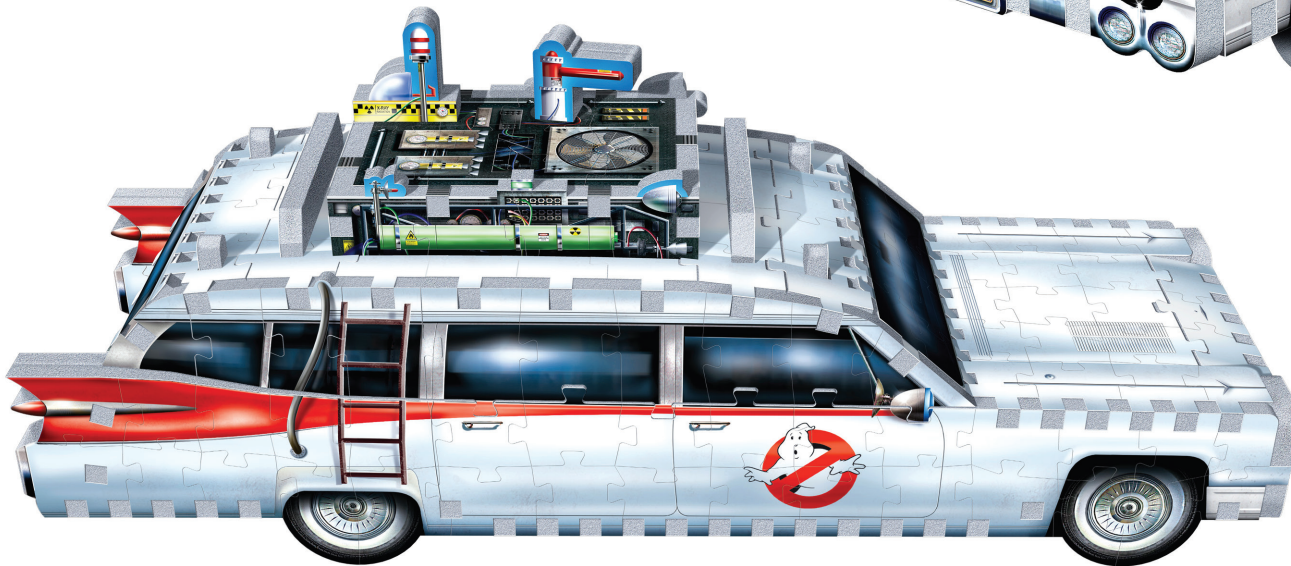

Ghostbusters | Ecto-1 | 280 ✨

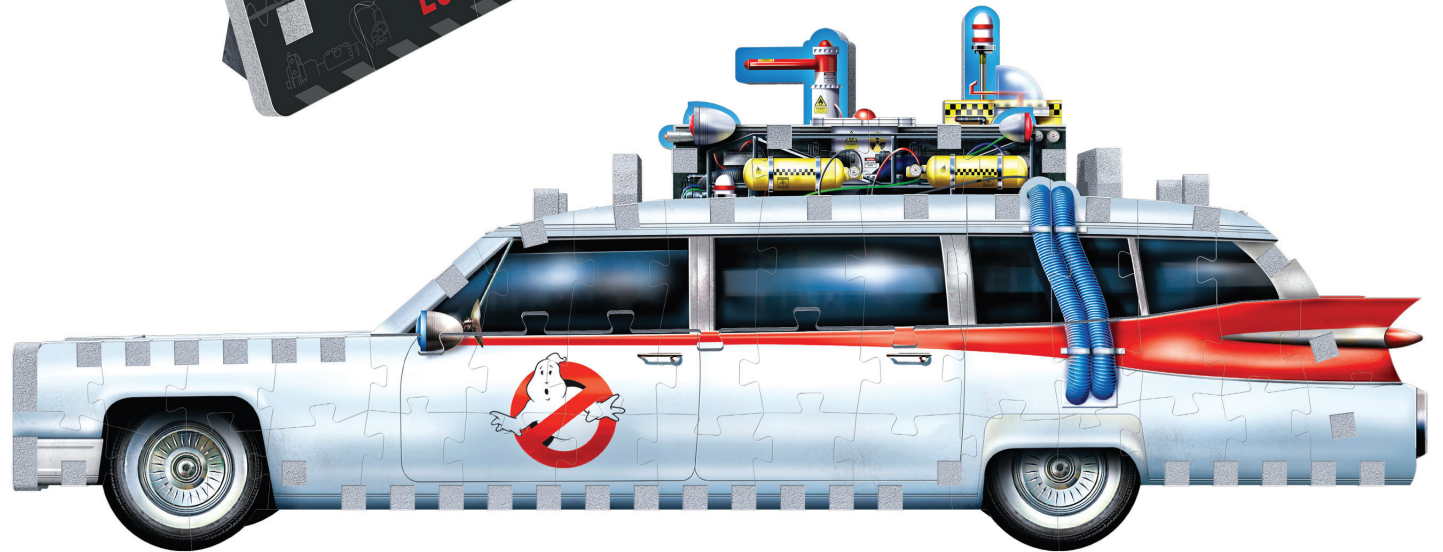
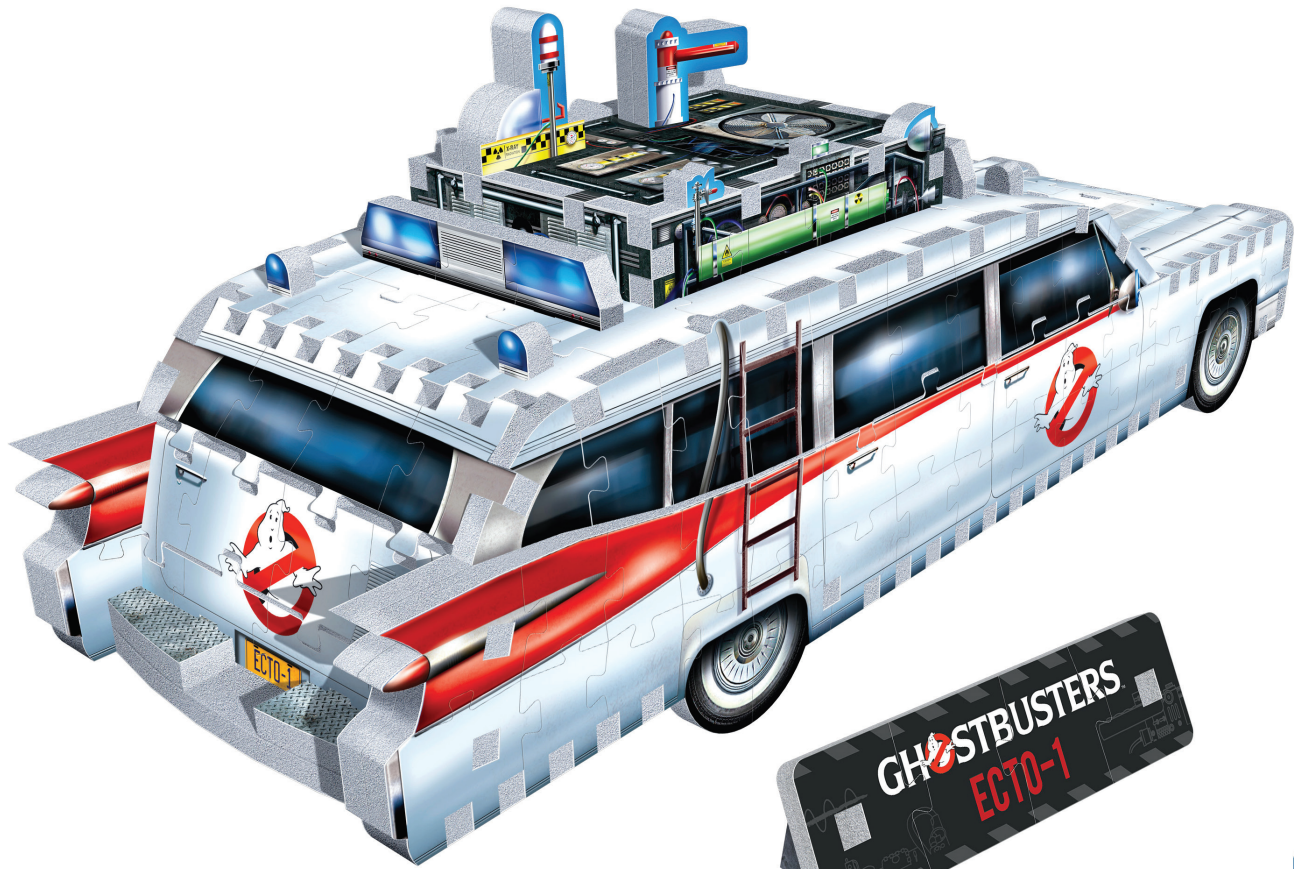

Ghostbusters | Ecto-1 | 280 🧩



1

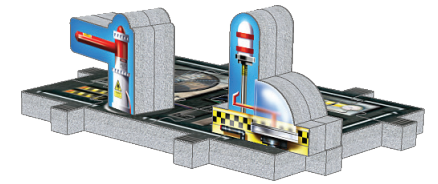
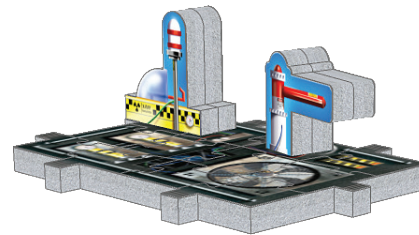
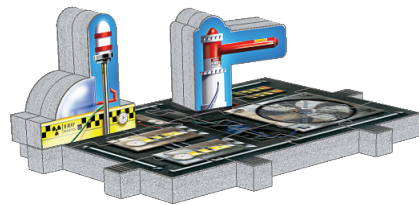
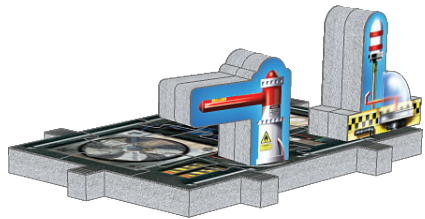
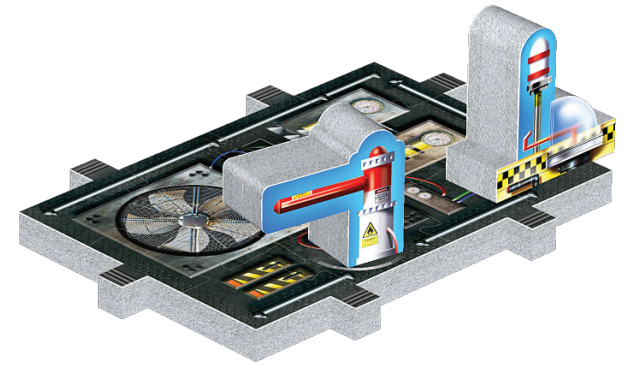
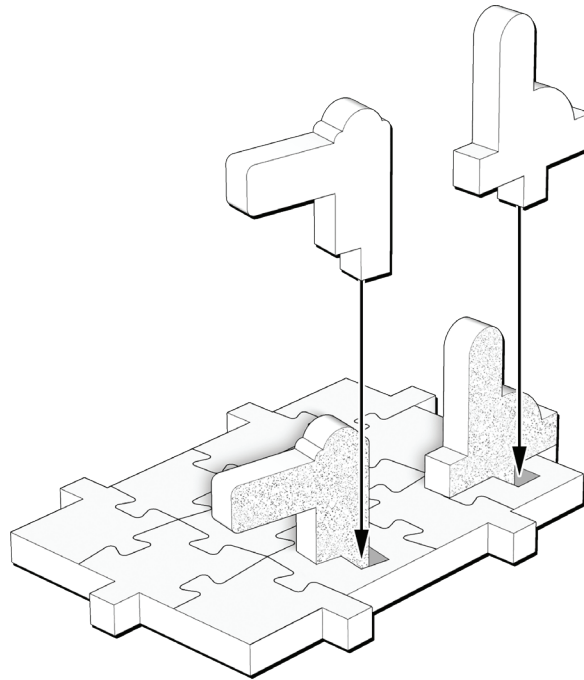
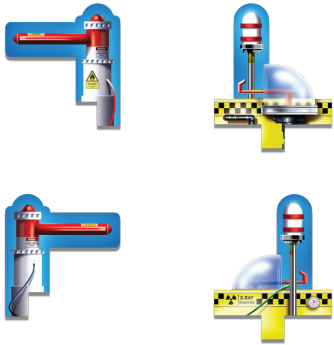
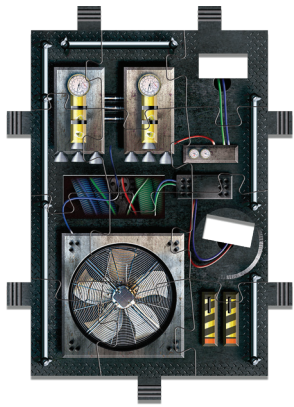



2

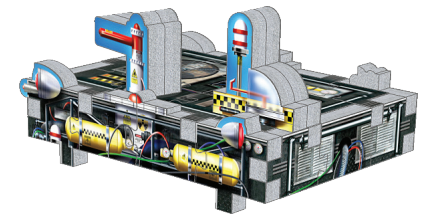
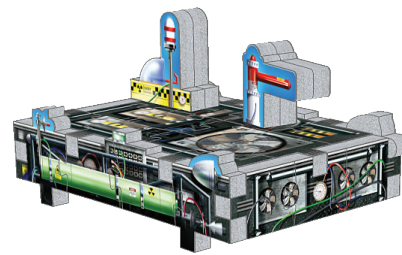
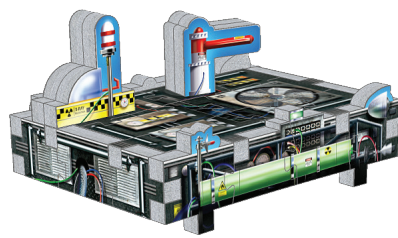
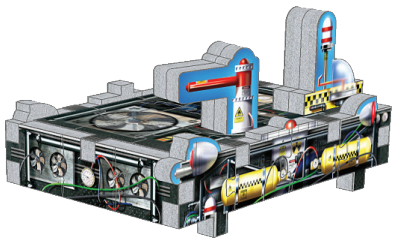
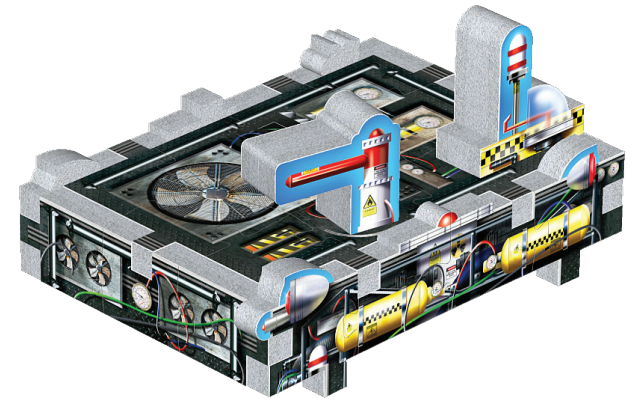
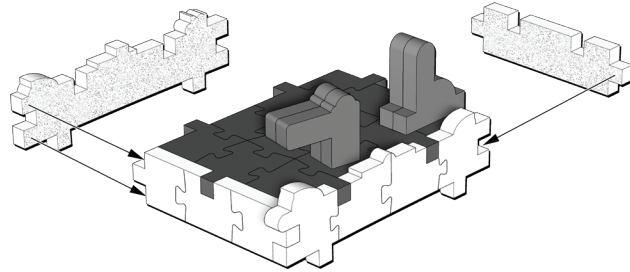
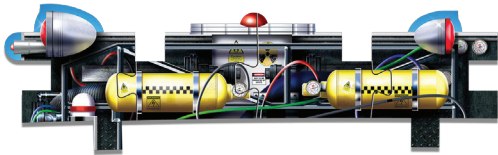
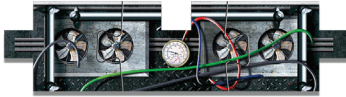
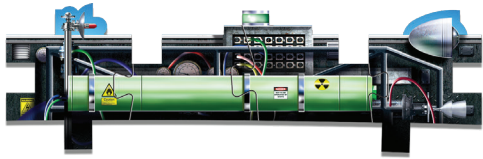

3

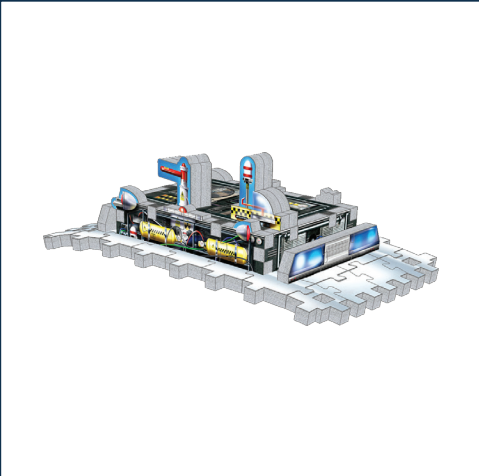
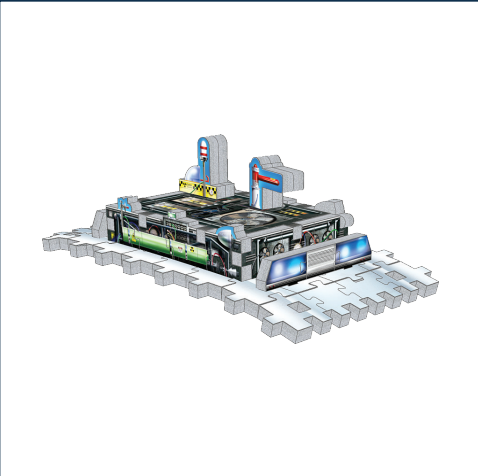
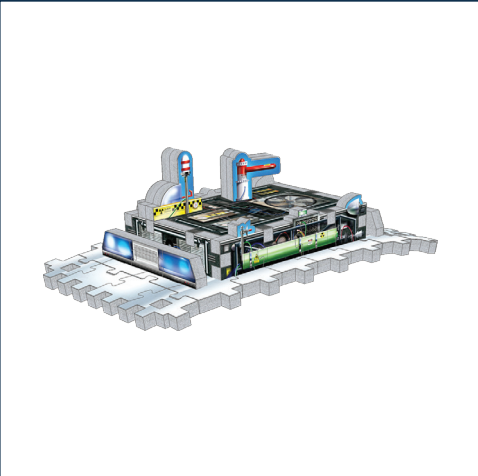
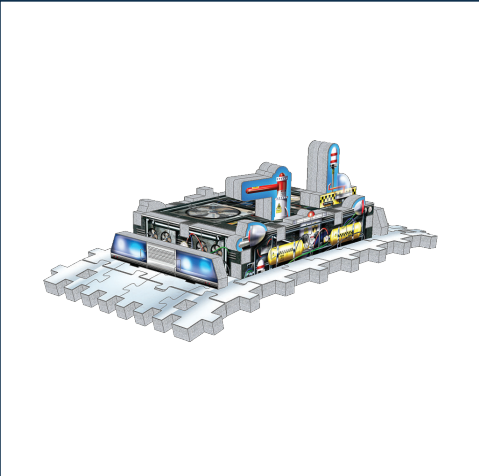
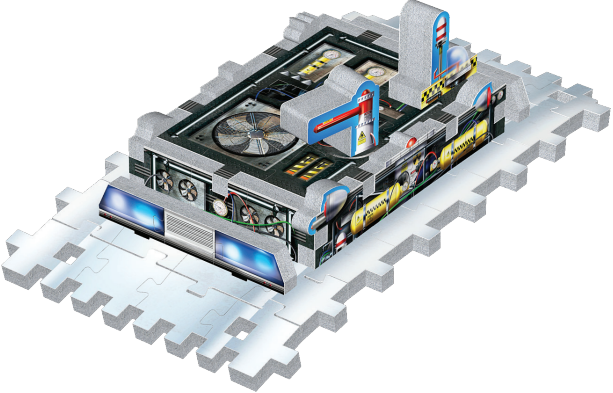
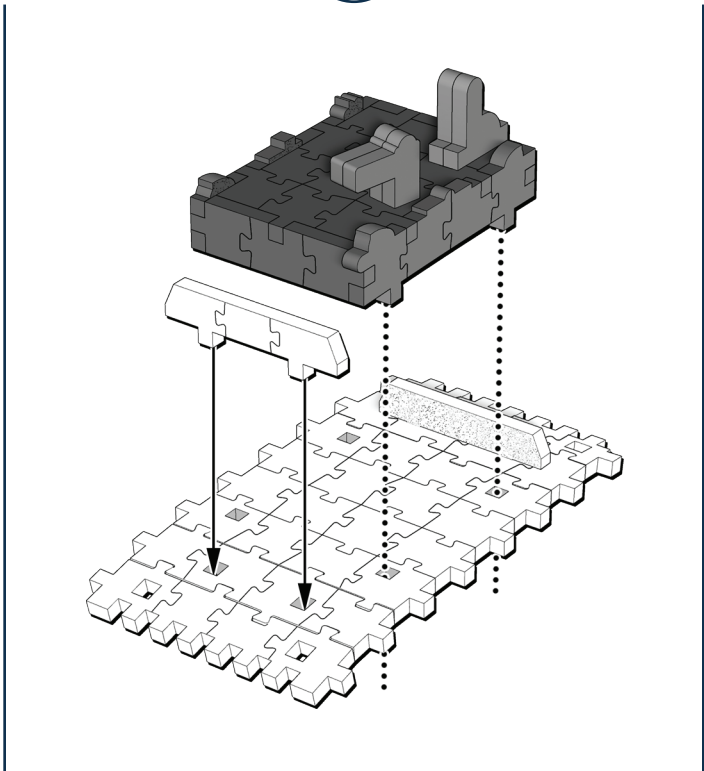
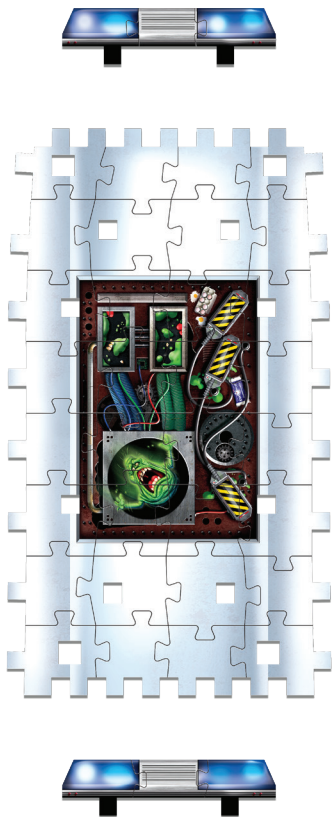



4

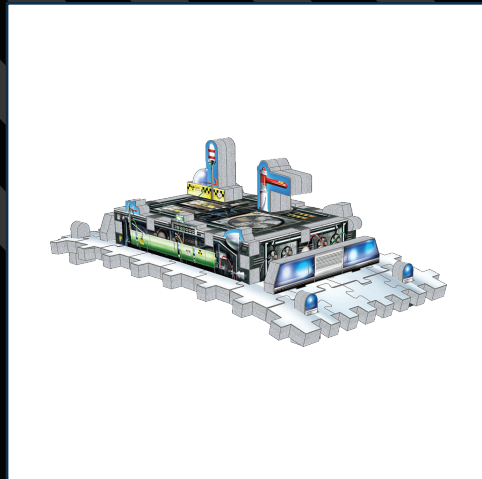
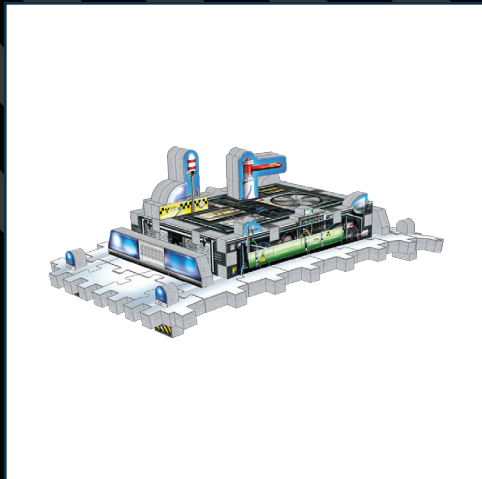
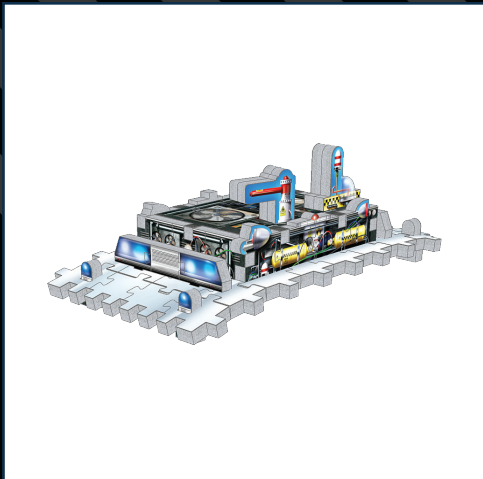
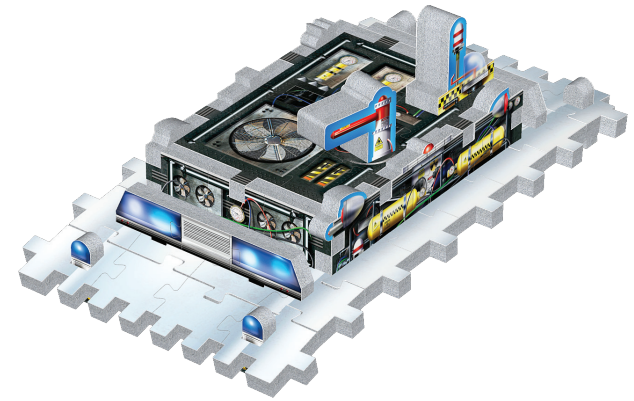
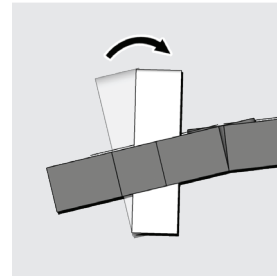
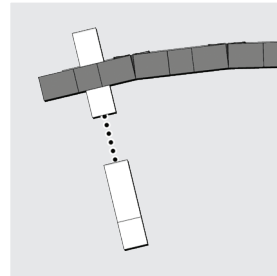
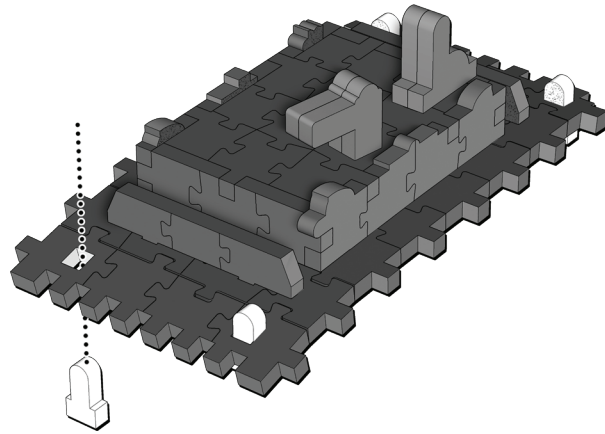

5

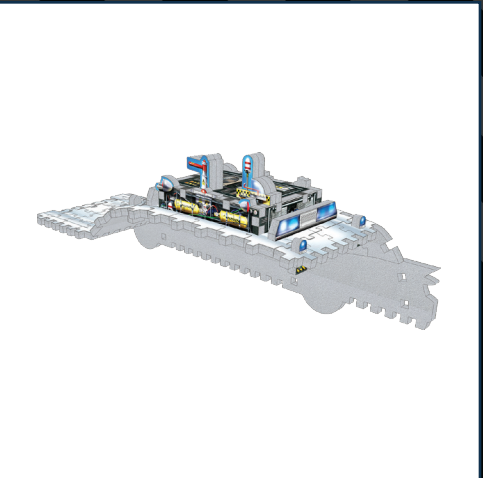
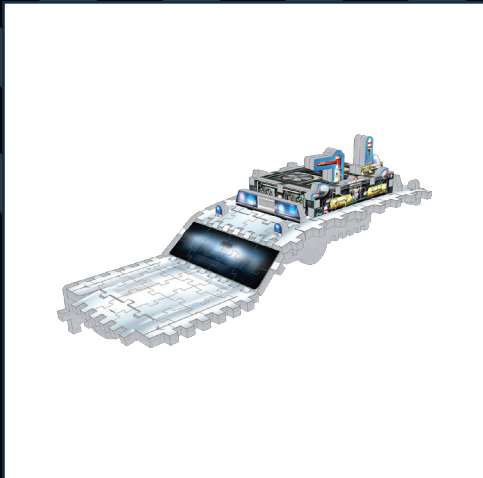
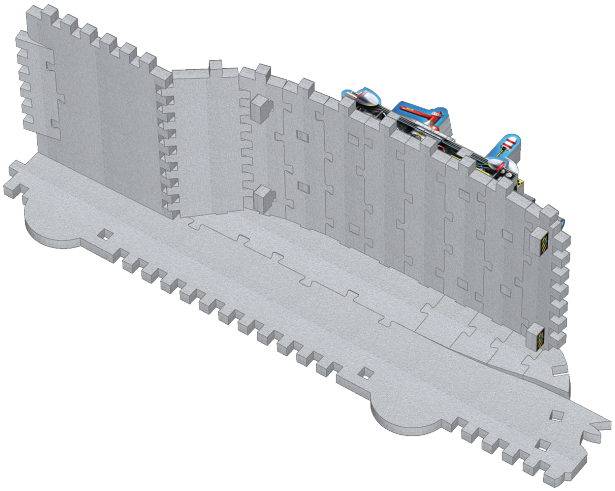
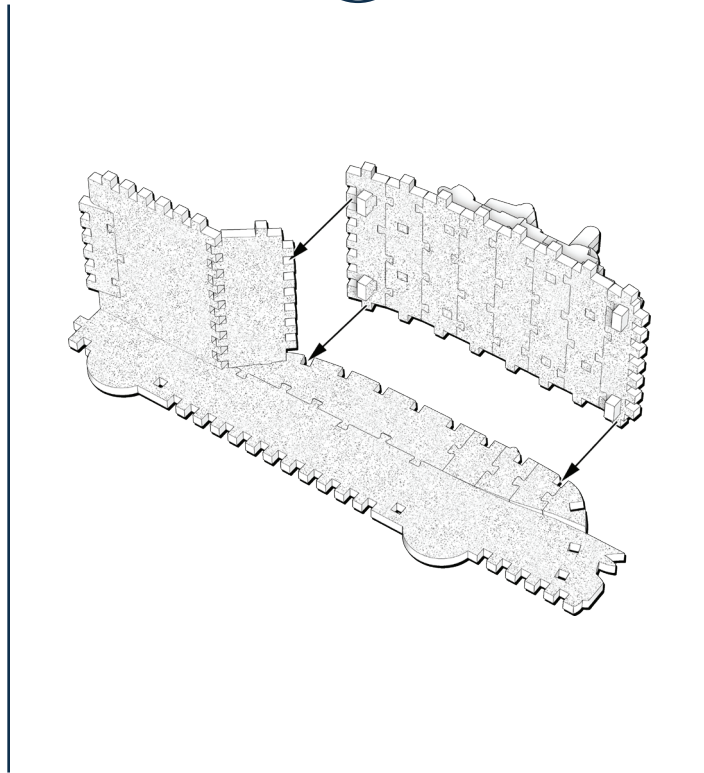
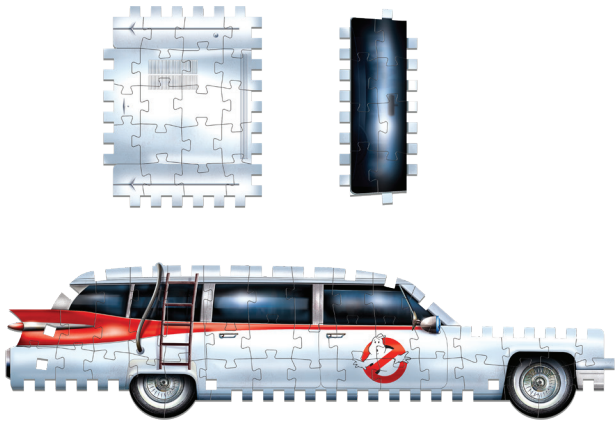



6

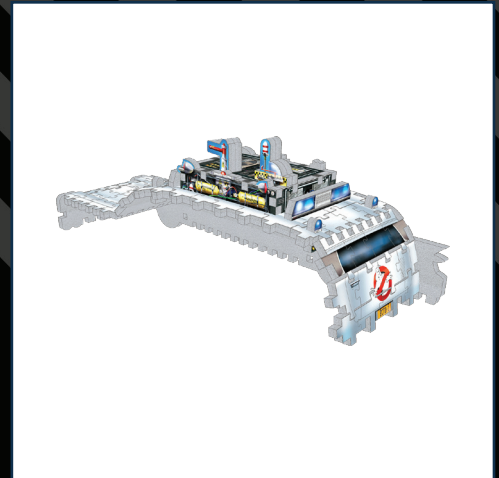
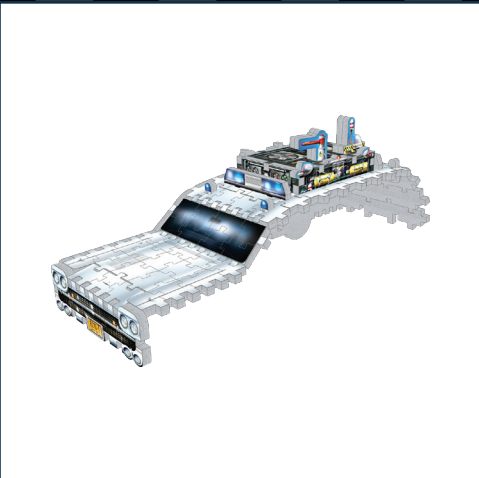
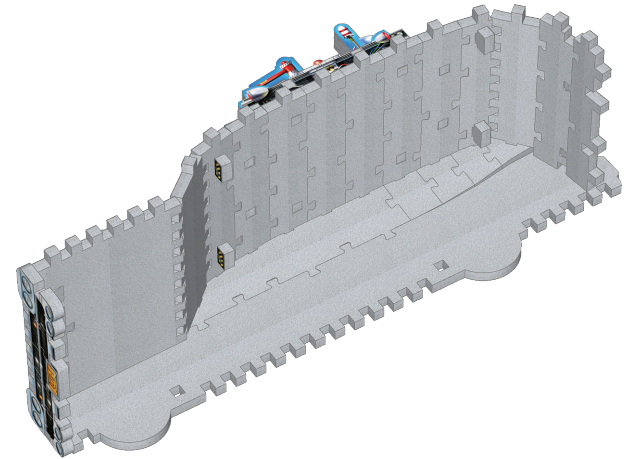
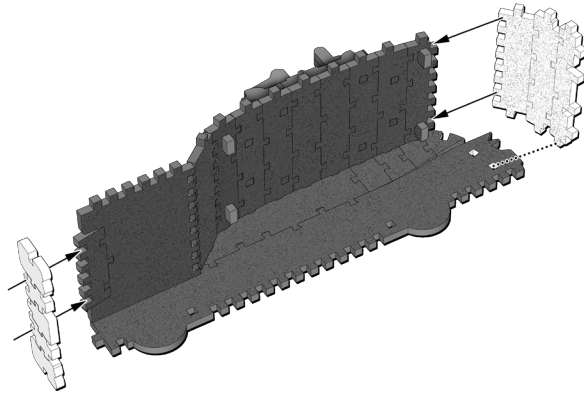
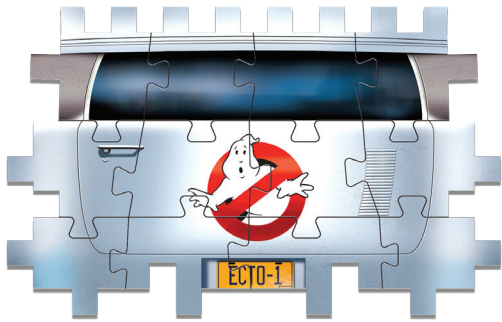

7

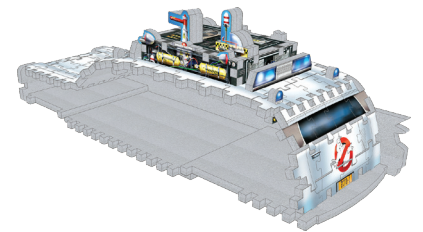
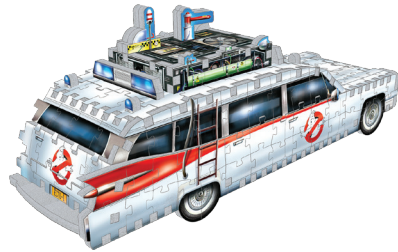
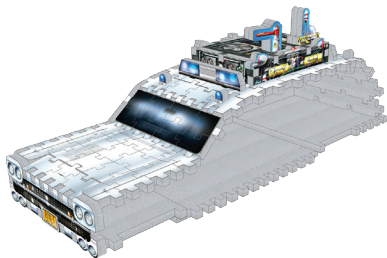
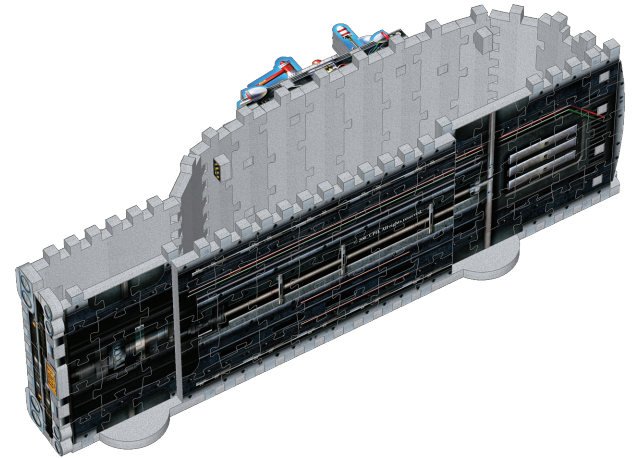
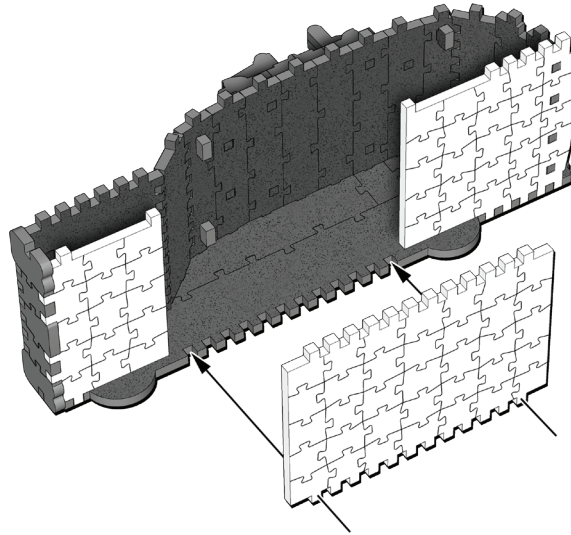
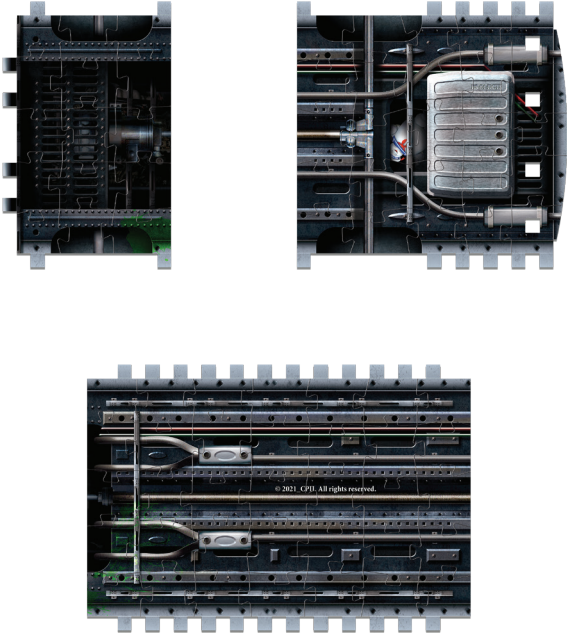



8

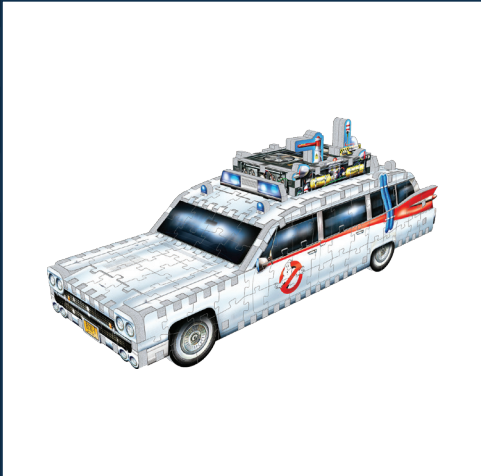
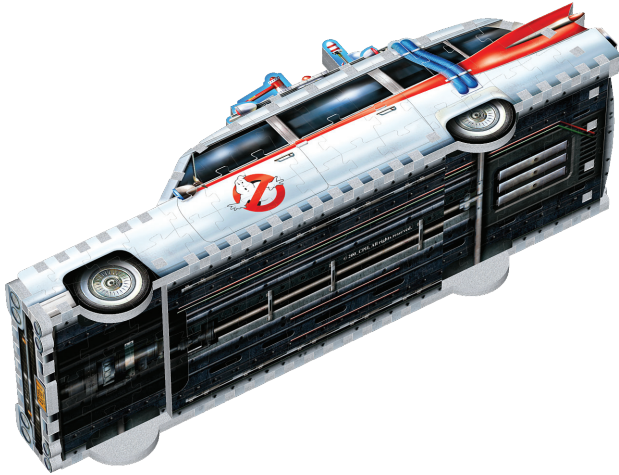
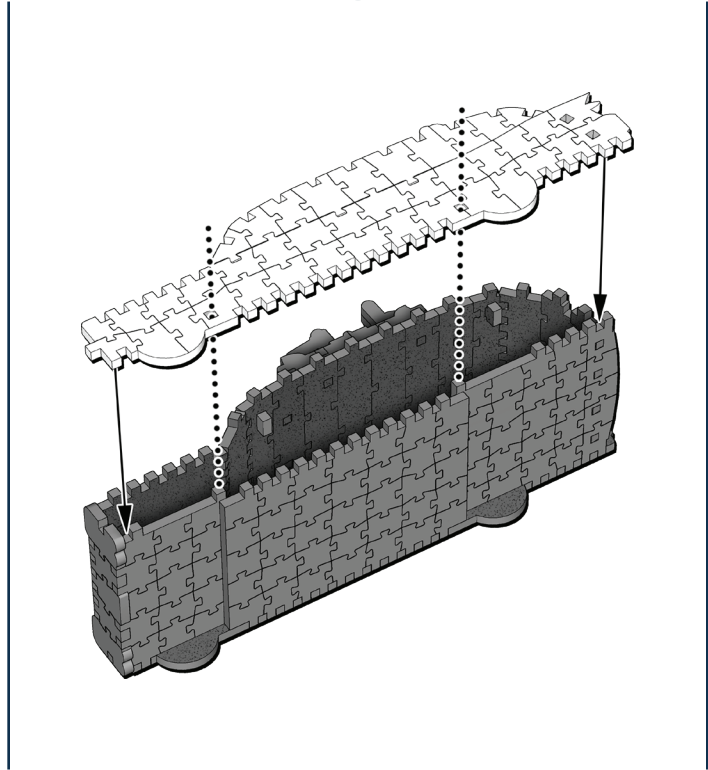
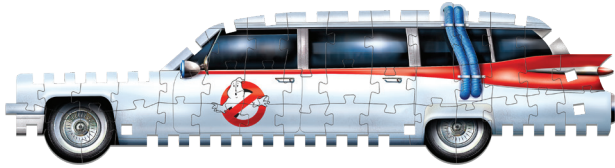

9

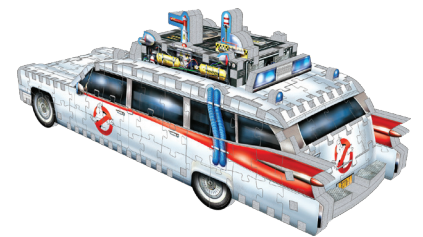
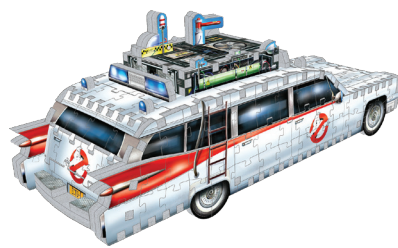
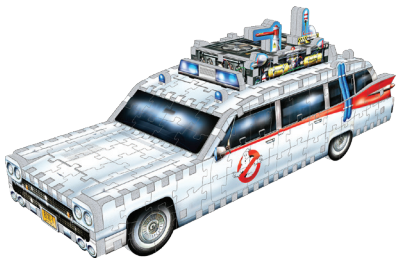
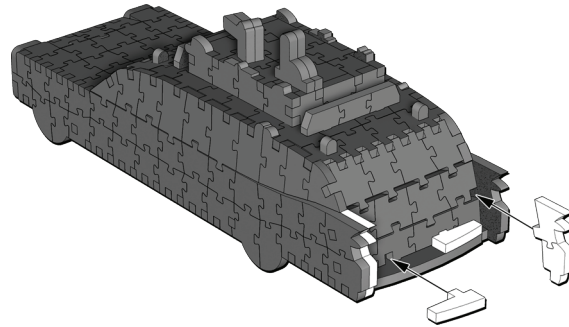
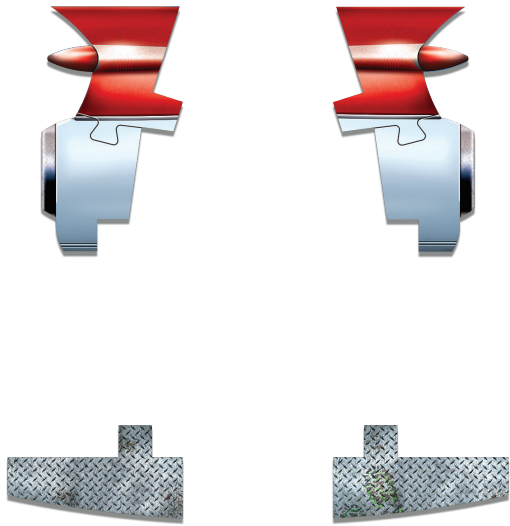



10

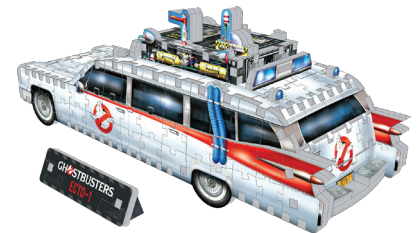
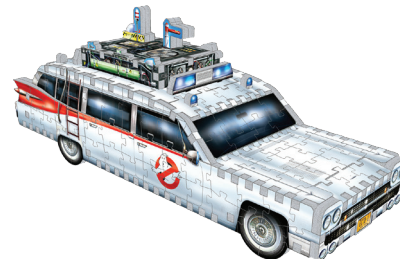
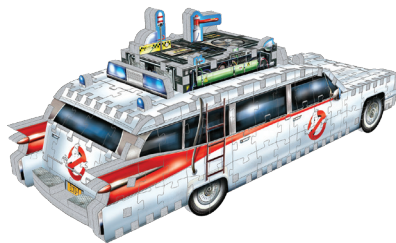
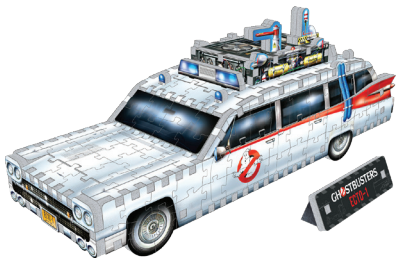
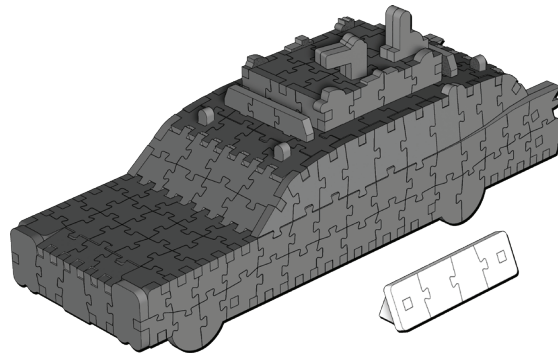

# GH**OS**TBUSTERS™

**Wrebbit** **#3**  
PUZZLE™



TM & © 2021 Columbia Pictures Industries, Inc. All Rights Reserved.

MC & © 2021 Columbia Pictures Industries, Inc. Tous droits réservés.

© 2021 Wrebbit Puzzles Inc. All rights reserved. Wrebbit and Wrebbit3D are trademarks of Wrebbit Puzzles Inc. Manufactured and distributed by Wrebbit Puzzles Inc.

© 2021 Les Casse-Têtes Wrebbit Inc. Tous droits réservés. Wrebbit et Wrebbit3D sont des marques de commerce de Les Casse-Têtes Wrebbit Inc. Fabriqué et distribué par Les Casse-Têtes Wrebbit Inc.

*Product and color specifications may vary slightly.*

*Les caractéristiques et couleurs du produit peuvent varier légèrement.*