



CIRCUIT
BLOX™

BURP & FART MACHINE



INSTRUCTIONS

COMPONENT LIST

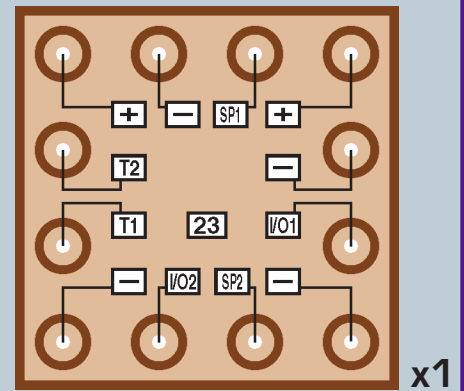
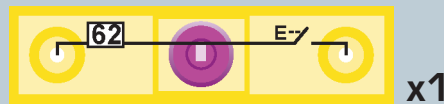
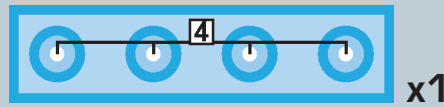
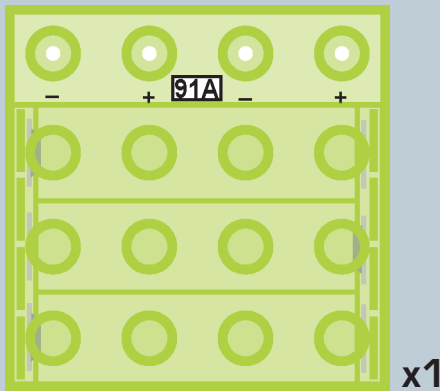

Note:

Do not mix old and new batteries.

Do not mix alkaline, standard (carbon-zinc), or rechargeable batteries.

PROJECT

Build the circuit shown, turn on the switch (62) by pressing it to the DOWN position, and you will hear a funny fart sound. Press and release the Press Switch (61) and you will hear another funny burp or fart sound. Keep pressing and releasing the Press Switch (61) to continue to hear more funny Burp and Fart sounds. You will also hear some reactions of boys and girls listening to the funny burp and fart sounds.

Turn off the switch (62) by pressing and releasing it to the UP position. Always make sure to turn off the Switch (62) when you are done playing with the burp & fart machine to save battery life. When you turn the Switch (62) ON again, the sequence of burp and fart sounds will start over again.

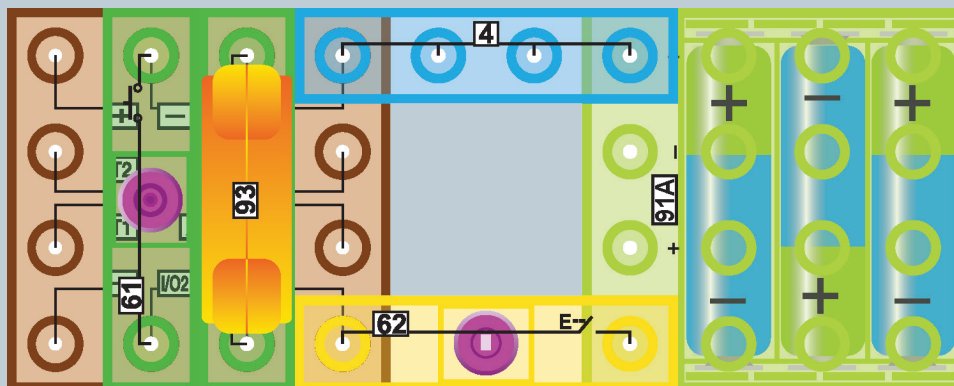

BATTERY SAFETY

- Use only 1.5V "AA" type, alkaline batteries (not included).
- Insert batteries with correct polarity.
- Non-rechargeable batteries should not be recharged.
- Rechargeable batteries should only be charged under adult supervision, and should not be recharged while in the product.
- Do not mix old and new batteries.
- Do not mix alkaline, standard (carbon-zinc), or rechargeable (nickel-cadmium) batteries.
- Remove batteries when they are used up.
- Do not short circuit the battery terminals.
- Never throw batteries in a fire or attempt to open their outer casing.
- Batteries are harmful if swallowed, so keep away from small children.

OTHER CIRCUIT BLOX® PRODUCTS

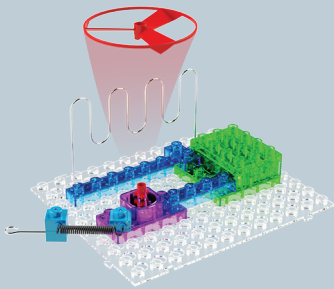

Fan Launch Challenge

How steady is your hand? Try to follow the maze with the hook without launching the fan. 8 pieces, including a motor, fan, maze, and more!

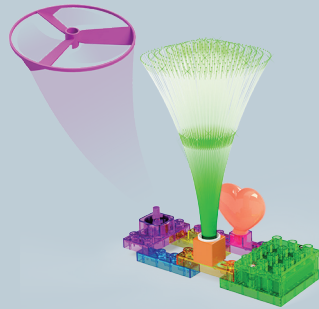

4 Projects

10 pieces, including a push-button switch, fiber optic tree, color-changing LED, heart LED, motor, fan, and more!

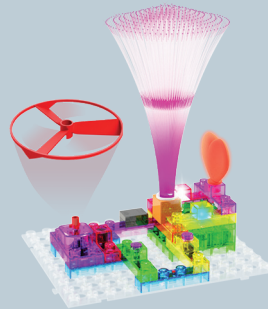

59 Projects

22 pieces, including three types of switches, fiber optic tree, bi-directional and color-changing LEDs, heart LED, motor, fan, buzzer, and more!

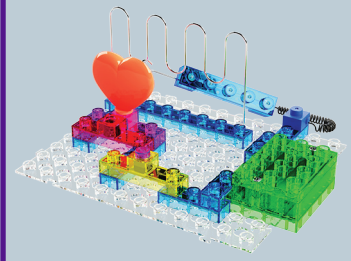

72 Projects

35 pieces, including a maze, hand crank generator, three types of switches, bi-directional, star, and heart LEDs, lamp, buzzer, and more!

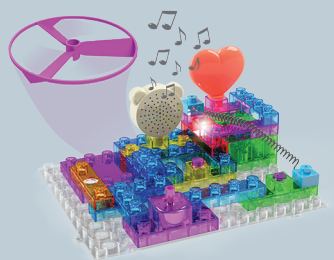

115 Projects

37 pieces, including a motor, 3 fans, sound module, speaker, four types of switches, heart LED, lamp, and more!

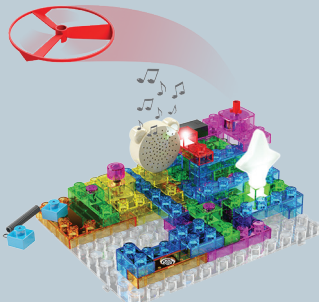

120 Projects

46 pieces, including a motor, 3 fans, sound and FM radio modules, speaker, four types of switches, star LED, lamp, and more!

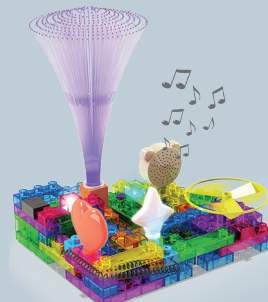

395 Projects

68 pieces, including a motor, 3 fans, sound and FM radio modules, speaker, resistors, capacitors, and transistor, heart and star LEDs, and more!

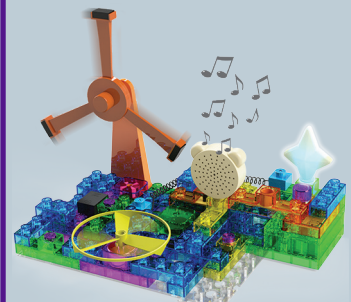

800 Projects

78 pieces, including a motor, 3 fans, inductor coil, magnet spinner, sound module, resistors, capacitors, and transistors, heart and star LEDs, and more!

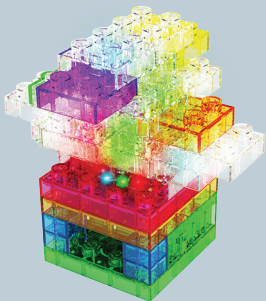

Lights Starter

32 pieces, including 25 transparent spacer blox. Sound activated, so put it by your speaker and watch the lights dance to the music or talk into it!

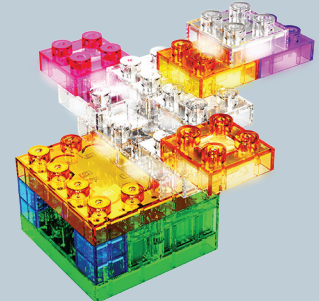

Lights Plus

19 pieces, including 12 LED blox and USB port. Touch activated! Several light settings such as pulsing, flashing, and continuous illumination.

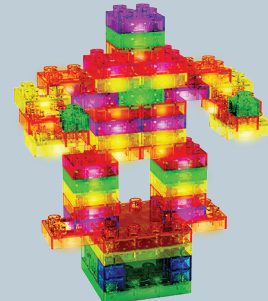

Lights Deluxe

147 pieces, including 24 LED blox, 2 base grids, and USB port. Sound and touch activated! Watch your creation's lights dance to music or your voice!

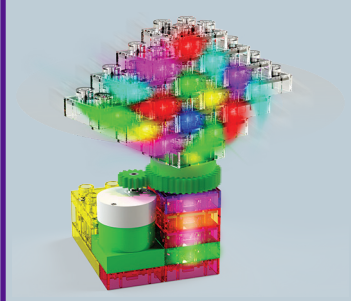

Lights 'n Motion

Create flashing structures that spin! 25 pieces, including 16 color-changing and 4 white LED blox, slow motor, and gear.