

SNAP CIRCUITS

ELENCO

OVER
125
EXCITING
PROJECTS

CONTAINS
OVER
45+
PARTS



STEM PRO
AUTHENTICATED
EDUCATIONAL PRODUCT

Ages
8-108

Rechargeable battery included
MADE WITH
CIRCUITSAFE
FUSE TECHNOLOGY

GREEN ENERGY

EXPLORATION IN ALTERNATIVE ENERGY



Project 101



ELENCO
Learn by doing.®

Table of Contents

For the best learning experience, do the projects in order.

Basic Troubleshooting	1	DO's and DON'Ts of Building Circuits	9
Parts List	2	Advanced Troubleshooting	10 - 11
How to Use It	3 - 4	Project Listings	12 - 13
About Your Snap Circuits® Green Parts	5 - 7	Projects 1 - 133	14 - 77
Introduction to Electricity	8	Other Snap Circuits® Products	78



WARNING: Moving parts. Do not touch the motor or fan during operation. If you have long hair, be careful that it does not get caught in the fan blade.



Warning to Snap Circuits® Owners: Do not connect additional voltage sources from other sets, or you may damage your parts. Also, do not connect the hand crank to parts from other sets or you may damage them. Contact ELENCO® if you have questions or need guidance.



WARNING: SHOCK HAZARD - Never connect Snap Circuits® to electrical outlets in your home!



WARNING: CHOKING HAZARD - Small parts. Not for children under 3 years.

Basic Troubleshooting

1. The battery (B4) will only work if it is charged. Project 3 shows how to recharge it.
2. Most circuit problems are due to incorrect assembly, always double-check that your circuit exactly matches the drawing for it.
3. Be sure that parts with positive/negative markings are positioned as per the drawing.
4. Be sure that all connections are securely snapped.
5. Sometimes the motor or solar cell is mounted on the pivot stand so its angle to the sun or wind can be adjusted. The pivot stand base, post, and top should be assembled together.

ELENCO® is not responsible for parts damaged due to incorrect wiring.

Note: If you suspect you have damaged parts, you can follow the Advanced Troubleshooting procedure on page 9 to determine which ones need replacing.

Conforms to all applicable government requirements.

The toy is only to be connected to Class II equipment bearing the symbol

WARNING: Always check your wiring before turning on a circuit. Never leave a circuit unattended while the batteries are installed. Never connect additional batteries or any other power sources to your circuits. Discard any cracked or broken parts.





































Adult Supervision: Because children's abilities vary so much, even with age groups, adults should exercise discretion as to which experiments are suitable and safe (the instructions should enable supervising adults to

establish the experiment's suitability for the child). Make sure your child reads and follows all of the relevant instructions and safety procedures, and keeps them at hand for reference.

This product is intended for use by adults and children who have attained sufficient maturity to read and follow directions and warnings.

Never modify your parts, as doing so may disable important safety features in them, and could put your child at risk of injury.

Parts List (colors and styles may vary) Symbols and Numbers

Qty.	ID	Name	Symbol	Part #	Qty.	ID	Name	Symbol	Part #
□ 1		Base Grid (11" x 7.7") Green Color		6SCBGGR	□ 1		Black Jumper Wire		6SCJ1
□ 2	①	1-Snap Wire		6SC01	□ 1		Red Jumper Wire		SCCJ2
□ 3	②	2-Snap Wire		6SC02	□ 1		Liquid Holder		6SCLH
□ 3	③	3-Snap Wire		6SC03	□ 1	Ⓜ4	Motor		6SCM4
□ 1	④	4-Snap Wire		6SC04	□ 1		Wind Fan		6SCM4B
□ 1	⑤	5-Snap Wire		6SC05	□ 1		Water Wheel		6SCM4C
□ 1	ⓑ4	Rechargeable Battery		6SCB4	□ 1	Ⓜ6	Meter		6SCM6
□ 1	ⓑ7	Solar Cell		6SCB7	□ 1		Mini Car		6SCMCAR
□ 1	ⓒ5	470mF Capacitor		6SCC5	□ 1		Pivot Stand Base		6SCPSB
□ 1	ⓓ8	Color LED		6SCD8	□ 1		Pivot Post		6SCPSP
□ 1	ⓓ10	Red/Yellow LED		6SCD10	□ 1		Pivot Top		6SCPST
□ 3		Copper Electrode		6SCEC	□ 2		Rubber Ring 0.375"		6SCRUBRG
□ 3		Zinc Electrode		6SCEZ	□ 1	Ⓢ2	Press Switch		6SCS2
□ 1		Copper Electrode with Snap		6SCECS	□ 1	Ⓢ6	Switcher		6SCS6
□ 1		Zinc Electrode with Snap		6SCEZS	□ 1	Ⓣ2	Clock		6SCT2
□ 1		Gear 1.75"		6SCGEAR2	□ 1	Ⓤ32	Melody IC		6SCU32
□ 1	Ⓜ	Geared Motor		6SCGM	□ 3		Nut 8-32		644800
□ 1		Crank Arm		6SCGMC	□ 3		Screw 8-32 Phillips		641840

Important: If any parts are missing or damaged, **DO NOT RETURN TO RETAILER.** Call toll-free (800) 533-2441 or e-mail us at: help@elenco.com
 Customer Service: 150 Carpenter Ave., Wheeling, IL 60090 U.S.A.. You may order additional/replacement parts at www.elenco.com/replacement-parts

How to Use It

Snap Circuits® uses building blocks with snaps to build the different electrical and electronic circuits in the projects. Each block has a function: there are switch blocks, light blocks, battery blocks, different length wire blocks, etc. These blocks are different colors and have numbers on them so that you can easily identify them. The circuit you will build is shown in color and numbers, identifying the blocks that you will use and snap together to form a circuit.

For Example:

This is the switch block which is green and has the marking S2 on it. The part symbols in this booklet may not exactly match the appearance of the actual parts, but will clearly identify them.



This is a wire block which is blue and comes in different wire lengths. This one has the number 2, 3, 4, or 5 on it depending on the length of the wire connection required.



There is also a 1-snap wire that is used as a spacer or for interconnection between different layers.



A large clear plastic base grid is included with this kit to help keep the circuit blocks properly spaced. You will see evenly spaced posts that the different blocks snap into. The base has rows labeled A-G and columns labeled 1-10.

Next to each part in every circuit drawing is a small number in black. This tells you which level the component is placed at. Place all parts on level 1 first, then all of the parts on level 2, then all of the parts on level 3, etc.

Some circuits use the jumper wires to make unusual connections. Just clip them to the metal snaps or as indicated.



Note: While building the projects, be careful not to accidentally make a direct connection across the battery holder (a "short circuit"), as this may damage and/or quickly drain the batteries.

Sometimes the crank arm will be mounted on the geared motor (GM) to produce a hand crank:

The 3.6V rechargeable battery (B4) may have discharged during shipping and distribution. Recharge it as shown in project 3.

Sometimes parts will be mounted on a pivot, so they can be adjusted for the best angle to the wind or sun. Assemble the pivot as shown here:

Insert post into pivot top, snapping into place.

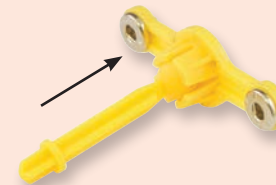

Insert the other end of the post into pivot base.

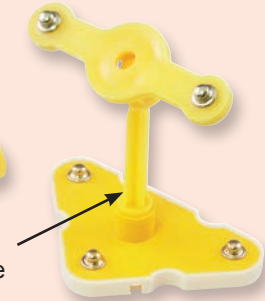

How to Use It

Whenever the motor (M4) is used, it will have the wind fan or the water wheel placed on top; simply push the fan onto the shaft. To remove it, push up on it with a screwdriver or your thumbs, being careful not to break it.

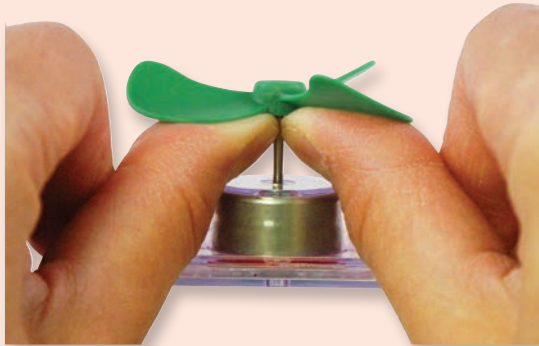

Assembling the Liquid Power Source:

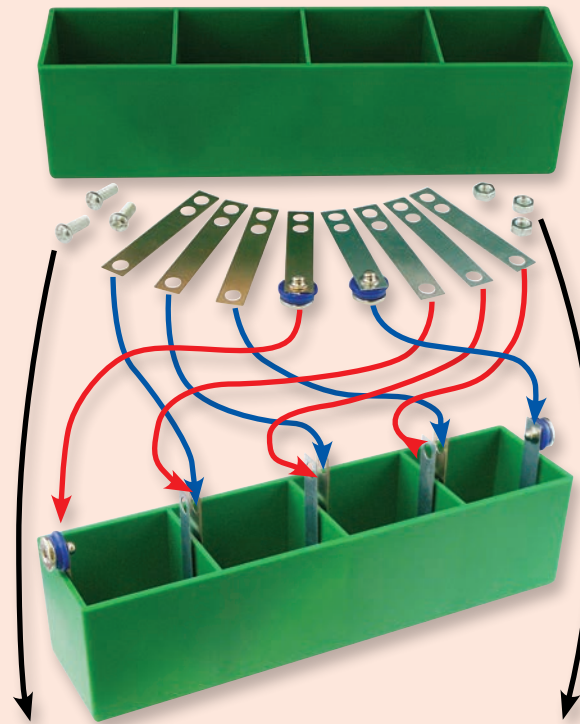

Connect the 3 electrode parts together with screws and nuts as shown. Tighten by hand, a screwdriver is not needed.

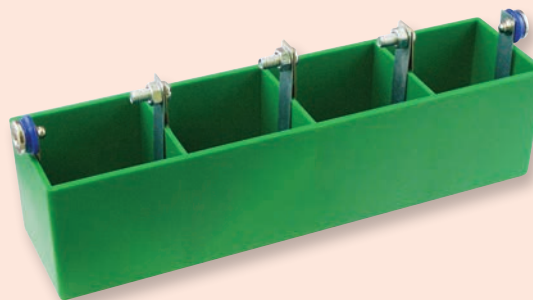

If the copper and zinc electrodes get corroded through use, use sandpaper, steel wool, or a scraper to remove the corrosion and improve performance.

Setting the time on the clock (T2):

- Press the left button to select what to change (month, date, hour, or minutes).
- Press the right button until it is correct.
- Press the left button until the time is showing, then press the right button once to start.
- The colon (":") will be flashing when the clock is running.
- Press the right button to display the date.

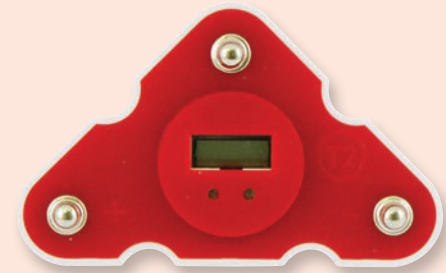

About Your Snap Circuits® Green Parts

BASE GRID

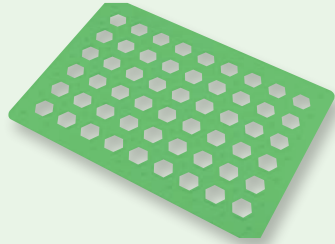

The **base grid** is a platform for mounting parts and wires. It functions like the printed circuit boards used in most electronic products, or like how the walls are used for mounting the electrical wiring in your home.

SNAP WIRES & JUMPER WIRES

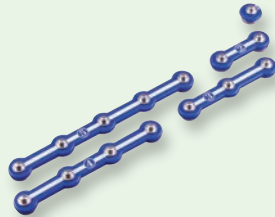

The blue **snap wires** are wires used to connect components. They are used to transport electricity and do not affect circuit performance. They come in different lengths to allow orderly arrangement of connections on the base grid.



The red & black **jumper wires** make flexible connections for times when using the snap wires would be difficult. They're also used to make connections off the

base grid (like the projects using water).

Wires transport electricity just like pipes are used to transport water. The colorful plastic coating protects them and prevents electricity from getting in or out.

BATTERY

Battery (B4)



The **battery (B4)** contains a rechargeable battery and some supporting parts. This battery produces an electrical **voltage** using a reversible chemical reaction. This “voltage” can be thought of as electrical pressure, pushing electricity through a circuit just like a pump pushes water through pipes. This voltage is much lower and much safer than that used in your house wiring. Using more batteries increases the “pressure” and so more electricity flows.

SOLAR CELL

Solar Cell (B7)



The **solar cell (B7)** contains positively and negatively charged silicon crystals,

arranged in layers that cancel each other out. When sunlight shines on it, charged particles in the light unbalance the silicon layers and produce an electrical voltage of up to 7V. The maximum current depends on the type of light and its brightness, but will be much less than a battery can produce. Bright sunlight works best, but incandescent light bulbs also work.

LIQUID HOLDER & ELECTRODES

Electrodes

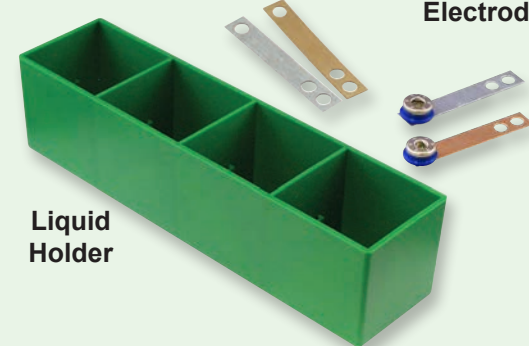

Liquid Holder

Most sodas and fruit juices are lightly acidic. The acid is similar to the material used in some types of batteries but not nearly as strong. The acid will react with the copper and zinc electrodes to make an electric current, like a battery. Each of the four compartments in the liquid holder produces about 0.7V, but the current is very low and may not last long.

(Part designs are subject to change without notice).

About Your Snap Circuits® Green Parts

METER

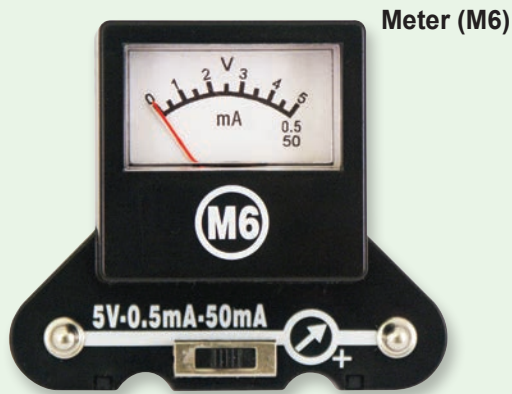

The **meter (M6)** is an important measuring device. You will use it to measure the voltage (electrical pressure) and **current** (how fast electricity is flowing) in a circuit.

The meter measures voltage when connected in parallel to a circuit and measures the current when connected in series in a circuit.

This meter has one voltage scale (5V) and two current scales (0.5mA and 50mA). These use the same meter but with internal components that scale the measurement into the desired range. Sometimes resistors in the pivot stand will be used to change the 5V scale to 10V, or the 0.5mA scale to 5mA.



Meter Symbol

Inside the meter there is a fixed magnet and a movable coil around it. As current

flows through the coil, it creates a magnetic field. The interaction of the two magnetic fields causes the coil (connected to the pointer) to move (deflect).

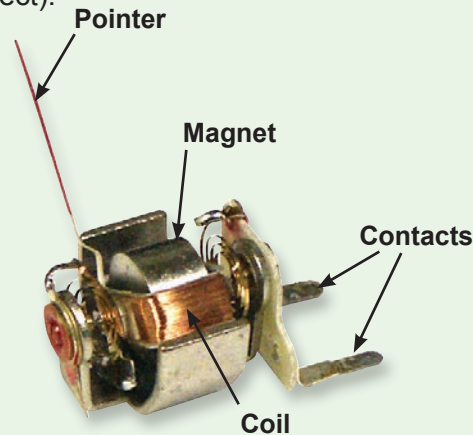

MOTOR



The **motor (M4)** converts electricity into mechanical motion. An electric current through the motor will turn the shaft.

It can also be used as a generator, since it produces an electric current when the shaft is turned.



Motor Symbol

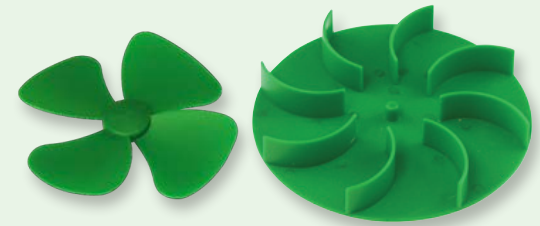

Wind Fan

Water Wheel

How does electricity turn the shaft in the motor? The answer is magnetism. Electricity is closely related to magnetism & an electric current flowing in a wire has a magnetic field similar to that of a very, very tiny magnet. Inside the motor is a coil of wire with many loops. If a large electric current flows through the loops, the magnetic effects become concentrated enough to move the coil.

The motor has a magnet inside, so as the electricity moves the coil to align it with the permanent magnet, the shaft spins.

When used as a generator, wind or water turns the shaft. A coil of wire is on the shaft, and as it spins past the permanent magnet an electric current is created in the wire.

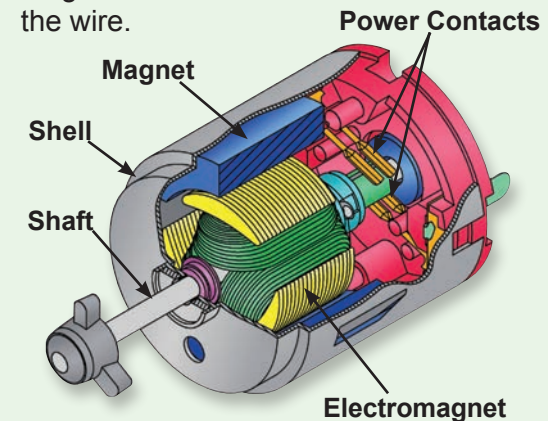

About Your Snap Circuits® Green Parts

GEARED MOTOR

Geared Motor & Crank Arm

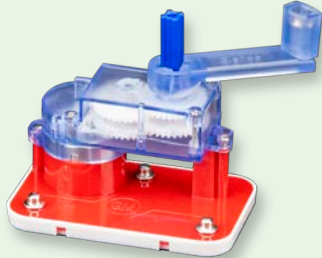

The **geared motor (GM)** is a motor with a gearbox attached. The crank arm may be attached to it so it can be turned by hand. The gearbox spins the motor shaft faster but with less force than when turning the crank arm.

SWITCHES

Press Switch (S2)



The **press switch (S2)** connects (pressed, "ON") or disconnects (not pressed, "OFF") the wires in a circuit. When ON it has no effect on circuit performance. It turns on electricity just like a faucet turns on water from a pipe.

The **switcher (S6)** is a more complex switch used to reverse the wires to a component or circuit. See project 18 for an example of connections.

Switcher (S6)



Its symbol & connections look like this:

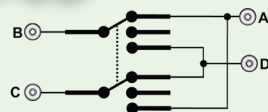

RED & YELLOW LEDs

The **color LED (D8)** and **red/yellow bicolor LED (D10)** are light emitting diodes, and may be thought of as a special one-way light bulbs. In the "forward" direction, (indicated by the "arrow" in the symbol) electricity flows if the voltage exceeds a turn-on threshold (about 1.5V for red, slightly higher for yellow, about 2.0V for green, and about 3.0V for blue); brightness then increases. The color LED contains red, green, and blue LEDs, with a micro-circuit controlling them. The red/yellow bicolor LED contains red & yellow LEDs in connected in opposite directions. A high current will burn out an LED, so the current must be limited by other components in the circuit (though your Snap Circuits® LEDs have internal resistors to protect against incorrect wiring). LEDs block electricity in the "reverse" direction.

LEDs (D8 & D10)



CAPACITOR

Capacitor (C5)



The **470mF capacitor (C5)** can store electrical pressure (voltage) for periods of time. This storage ability allows it to block stable voltage signals and pass changing ones. Capacitors are used for filtering and delay circuits.

OTHER PARTS

Melody IC (U32)



The **melody IC (U32)** contains a specialized sound-generation integrated circuit (IC), a small speaker, and a few supporting components. The IC has a recording of the melody, which it makes into an electrical signal for the speaker. The speaker converts the signal into mechanical vibrations. The vibrations create variations in air pressure, which travel across the room. You "hear" sound when your ears feel these air pressure variations.

Clock (T2)



The **clock (T2)** contains a small crystal. When a crystal is struck by an electronic pulse, it vibrates. A microelectronic circuit makes the pulse and measures the vibration rate. The vibration rate is used as a time standard, from which minutes, hours, and the date are calculated.

Pivot Stand



The pivot stand contains two resistors, 47W and 10KW. **Resistors** "resist" the flow of electricity and are used to control or limit the electricity in a circuit. Materials like metal have very low resistance (<1W), while materials like paper, plastic, and air have near-infinite resistance. Increasing circuit resistance reduces the flow of electricity.

Introduction to Electricity

What is electricity? Nobody really knows. We only know how to produce it, understand its properties, and how to control it. Electricity is the movement of sub-atomic charged particles (called **electrons**) through a material due to electrical pressure across the material, such as from a battery.

Power sources, such as batteries, push electricity through a circuit, like a pump pushes water through pipes. Wires carry electricity, like pipes carry water. Devices like LEDs, motors, and speakers use the energy in electricity to do things. Switches and transistors control the flow of electricity like valves and faucets control water. Resistors limit the flow of electricity.

The electrical pressure exerted by a battery or other power source is called **voltage** and is measured in **volts (V)**. Notice the “+” and “-” signs on the battery; these indicate which direction the battery will “pump” the electricity.

The **electric current** is a measure of how fast electricity is flowing in a wire, just as the water current describes how fast water is flowing in a pipe. It is expressed in **amperes (A)** or **milliamps (mA, 1/1000 of an ampere)**.

The “**power**” of electricity is a measure of how fast energy is moving through a wire. It is a combination of the voltage and current (Power = Voltage x Current). It is expressed in **watts (W)**.

The **resistance** of a component or circuit represents how much it resists the electrical pressure (voltage) and limits the flow of electric current. The relationship is Voltage = Current x Resistance. When the resistance increases, less current flows. Resistance is measured in **ohms (Ω)**, or **kilo ohms (kW, 1000 ohms)**.

Nearly all of the electricity used in our world is produced at enormous generators driven by steam or water pressure. Wires are used to efficiently transport this energy to homes and businesses where it is used. Motors convert the electricity back into mechanical form to drive machinery and appliances. The most important aspect of electricity in our society is that it allows energy to be easily transported over distances.

Note that “distances” includes not just large distances but also

tiny distances. Try to imagine a plumbing structure of the same complexity as the circuitry inside a portable radio - it would have to be large because we can't make water pipes so small. Electricity allows complex designs to be made very small.

There are two ways of arranging parts in a circuit, in series or in parallel. Here are examples:

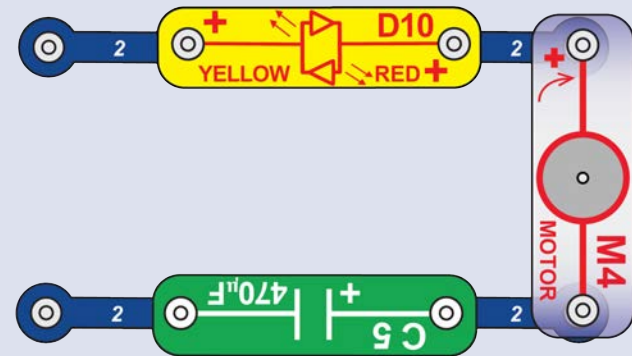

Series Circuit

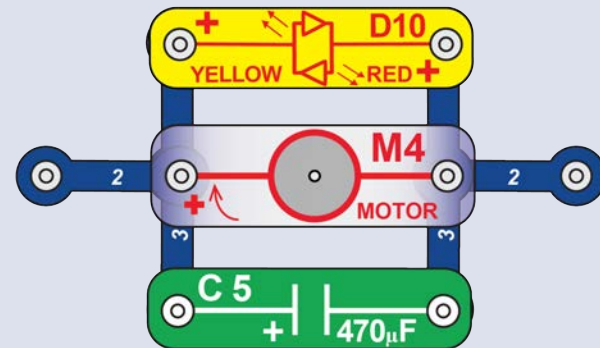

Parallel Circuit

Placing components in series increases the resistance; highest value dominates. Placing components in parallel decreases the resistance; lowest value dominates.

The parts within these series and parallel sub-circuits may be arranged in different ways without changing what the circuit does. Large circuits are made of combinations of smaller series and parallel circuits.

DO's and DON'Ts of Building Circuits

After building the circuits given in this booklet, you may wish to experiment on your own. Use the projects in this booklet as a guide, as many important design concepts are introduced throughout them. Every circuit will include a power source (like a battery), a resistance (which might be a light, motor, sound module, etc.), and wiring paths between them and back. **You must be careful not to create "short circuits" (very low-resistance paths across a power source, see examples below) as this will damage components and/or quickly drain your battery.**

ELENCO® Electronics is not responsible for parts damaged due to incorrect wiring.

Here are some important guidelines:

- ALWAYS** use eye protection when experimenting on your own.
- ALWAYS** include at least one component that will limit the current through a circuit, such as an LED, clock, or melody IC.
- ALWAYS** use the switches in conjunction with other components that will limit the current through them. Failure to do so will create a short circuit and/or damage those parts.
- ALWAYS** disconnect your batteries immediately and check your wiring if something appears to be getting hot.
- ALWAYS** check your wiring before turning on a circuit.
- NEVER** connect to an electrical outlet in your home in any way.
- NEVER** touch the motor when it is spinning at high speed.

For all of the projects given in this book, the parts may be arranged in different ways without changing the circuit. For example, the order of parts connected in series or in parallel does not matter — what matters is how combinations of these sub-circuits are arranged together.



Warning to Snap Circuits® owners: Do not connect additional voltage sources from other sets, or you may damage your parts. Also, do not connect the hand crank to parts from other sets or you may damage them. Contact ELENCO® if you have questions or need guidance.

Examples of SHORT CIRCUITS - NEVER DO THESE!!!

Placing a 3-snap wire directly across a power source is a SHORT CIRCUIT.



NEVER DO!

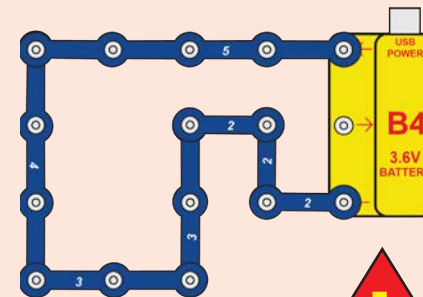
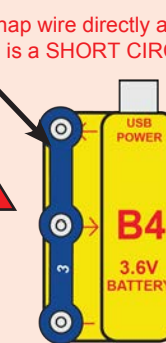

This is also a SHORT CIRCUIT.



NEVER DO!



NEVER DO!

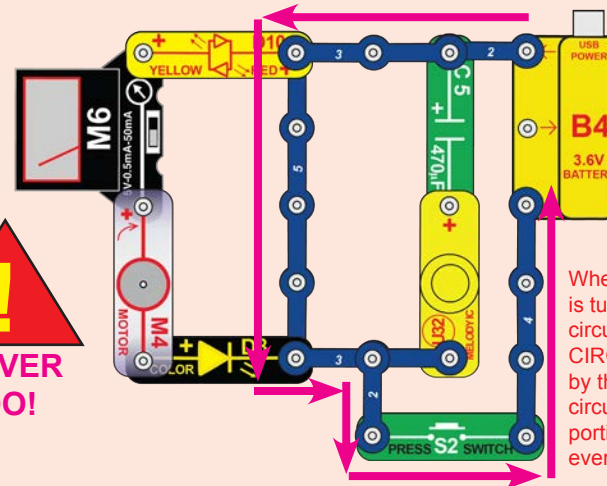

When the switch (S2) is turned on, this large circuit has a SHORT CIRCUIT path (as shown by the arrows). The short circuit prevents any other portions of the circuit from ever working.

You are encouraged to tell us about new circuits you create. If they are unique, we will post them with your name and state on our website at www.elenco.com/for-makers. Send your suggestions to Elenco Electronics: elenco@elenco.com.

Elenco® provides a circuit designer so that you can make your own Snap Circuits® drawings. This Microsoft® Word document can be downloaded from www.elenco.com/for-makers.



WARNING: SHOCK HAZARD - Never connect your Snap Circuits® set to the electrical outlets in your home in any way!

Advanced Troubleshooting (Adult supervision recommended)

Elenco® Electronics is not responsible for parts damaged due to incorrect wiring.

If you suspect you have damaged parts, you can follow this procedure to systematically determine which ones need replacing:

1. **Geared motor (GM), solar cell (B7), and meter (M6):** Place the meter directly across the solar cell and set it to the 5V setting. Place the solar cell in sunlight or near a bright light source (incandescent light bulbs are best); the meter pointer should move. Then place the meter directly across the geared motor, attach the crank arm to it, and turn the crank arm clockwise; the meter pointer should move for all the meter switch settings (5V, 0.5mA, and 50mA).
 - If the 5V meter setting works with the hand crank but not the solar cell, then the solar cell is damaged. Be sure you used a bright light source and removed any protective plastic wrap covering the solar cell.
 - If the 5V meter setting works with the solar cell but not the hand crank, then the hand crank is damaged.
 - If the 5V meter setting does not work with either the solar cell or the hand crank, then the meter is damaged.
 - If the 5V meter setting works with the hand crank but the 0.5mA or 50mA

meter settings do not, then the meter is damaged.

2. **Red & black jumper wires:** Set the meter to the 5V setting and use this circuit to test each jumper wire. Place the solar cell (B7) near the same light source you used in step 1. The jumper wire is damaged if the meter pointer does not move.

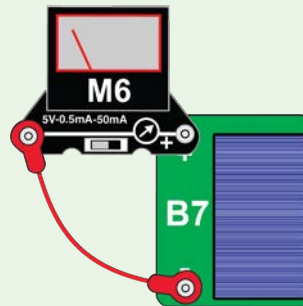

3. **Snap wires:** Set the meter to the 5V setting and use this circuit to test each snap wire, one at a time. Place the solar cell (B7) near the same light source you used in step 1. The snap wire is damaged if the meter pointer does not move.

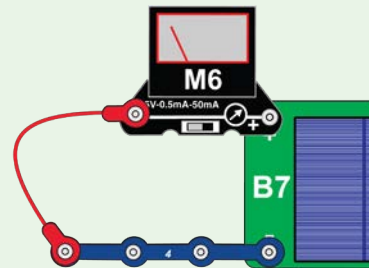

If you prefer, you can test all the snap wires at once using this circuit. If the

meter pointer does not move, then test the snap wires one at a time to find the damaged one.

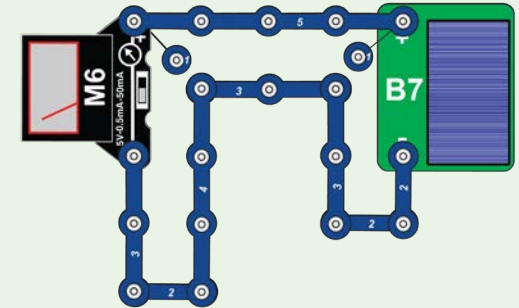

4. **Press switch (S2):** Set the meter to the 5V setting and build this circuit. Place the solar cell (B7) near the same light source you used in step 1. If the meter pointer does not move when you press the switch, the switch is damaged.

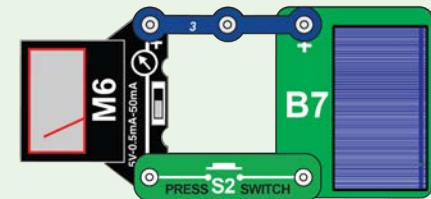

5. **Color and red/yellow bi-color LEDs (D8 & D10):** Place the crank arm on the geared motor (GM) and place each LED directly across the geared motor without snapping it on. Make sure the "+" side of the LED matches the "+" side of the hand crank. Turn the crank handle clockwise; the LED will light unless it is damaged. D10 will be either red or yellow, depending on how you oriented it.

Advanced Troubleshooting (continued)

6. **Battery (B4):** Plug B4 into a powered USB port; the “USB POWER” light on B4 should come on, indicating that it is being charged by the USB. Next, build the circuit shown here and set the meter (M6) to the 5V setting.

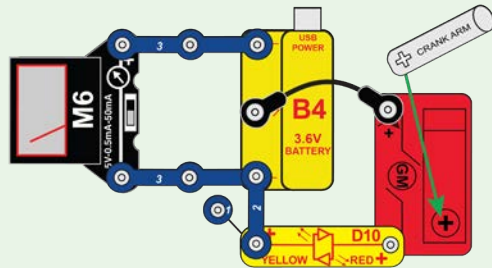

- The meter will measure more than 3V if the battery is charged up.
- If the meter pointer does not move from zero then either the battery is completely discharged or it is damaged.
- Turn the crank arm clockwise and check that the yellow LED (D10) comes on when you crank fast (indicating that the crank is charging the battery).
- If the meter was measuring zero then turn the crank for at least 20 seconds with the yellow LED on to see if it can be recharged.
- If the battery cannot be recharged, then it is damaged.
- If the battery needs to be recharged, you can use this circuit or see project 3 for other charging circuits.

7. **Switcher (S6):** Build this circuit and place the solar cell (B7) near the same light source you used in step 1. The LED (D10) should be red, when the switcher is in the top position, off when the switcher is in the middle position, and yellow when the switcher is in the bottom position; otherwise the switcher is damaged.

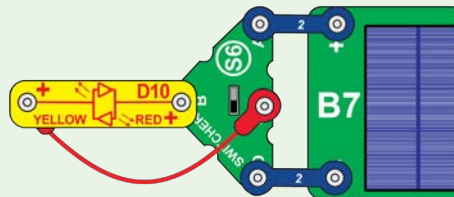

8. **Clock (T2), 470mF capacitor (C5), melody IC (U32), and motor (M4):** Build the circuit shown below, but remove the 470mF capacitor. Turn the crank arm clockwise and the clock display should turn on.

Add the 470mF capacitor back in; the clock display should stay on for a while after you stop turning the crank; arm otherwise the capacitor is damaged.

- Replace the clock with the melody IC. Turning the crank arm should make sound.
- Replace the melody IC with the motor (“+” on top, the fan doesn’t matter). Turning the crank arm clockwise should spin the motor shaft clockwise.

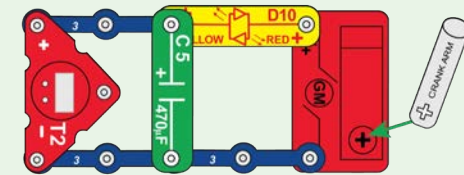

9. **Pivot stand resistors:** The pivot stand base has resistors mounted inside; they can be tested using this circuit. Set the switcher (S6) to the left position and turn the crank arm clockwise; the red/yellow LED (D10) should be bright red. Next, set the switcher to the right position and turn the crank arm clockwise; the color LED (D8) should be on but dim.

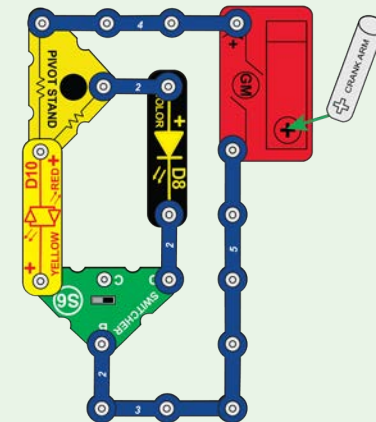

10. Check the remaining parts by inspecting them for damage.

ELENCO®

150 Carpenter Ave., Wheeling, IL 60090 U.S.A.
Phone: (847) 541-3800 • Fax: (847) 520-0085
e-mail: help@elenco.com • www.elenco.com

You may order additional / replacement parts at:
www.elenco.com/replacement-parts/

Project Listings

Project #	Description	Page #	Project #	Description	Page #	Project #	Description	Page #
1	Hand Cranking	14	26	Motor	27	45	Liquid Lights	35
2	Crank Charger	14	27	Water Wheel	27	46	Moving Voltage	36
3	Best Charging Circuits	15	28	Motor Voltage	27	47	Moving More Voltage	36
4	Solar Power	16	29	Crank Motor	28	48	Power Sources	37
5	Solar Color Power	16	30	Crank Motor Voltage	28	49	Powering Clock	38
6	Solar Motor	16	31	Fade Out	29	50	Powering Sound	38
7	Solar Charger 5mA	17	32	Mini Car with Wired Control	29	51	Powering LED	38
8	Long Light	17	33	Wired Control Car with Light/Sound	29	52	Powering Big Voltage	38
9	Windmill	18	34	Mini Car with on-Board Control	30	53	Powering Big Current	38
10	Windy Lights	18	35	Mini Car with on-Board Light	30	54	Splitting Current	39
11	Multi Power	19	36	Mini Car with on-Board Sound	31	55	Splitting Current Differently	39
12	Battery Power	19	37	Mini Car with Light & Sound	31	56	Wind Direction	39
13	Wind Warning	20	38	Mini Car with Solar Charge	31	57	Voltage Order	40
14	Light Charger	20	39	Fan Car	32	58	Current Order	41
15	Electric Circuit	21	B1	BONUS: Light Activated Car	32	59	Sources in Series	42
16	Close the Door	22	40	LED Currents	33	60	Sources in Parallel	42
17	Feeling Switchy	22	41	Battery Load	34	61	Two in Series	43
18	Reverser	23	42	Battery Load Current	34	62	Two in Parallel	43
19	Super Reverser	23	43	Make your Own Parts	35	63	Two LEDs Series	44
20	Voltage	24	44	Liquid Resistors	35	64	Two LEDs in Series-Filtered	44
21	Resistors	24				65	Two LEDs in Parallel	44
22	Light Emitting Diode	25				66	Wind Sound	45
23	Play a Tune	25				67	Windy Time	45
24	Clock	26				68	Wind Charger with Light	46
25	Capacitor	26						

Project Listings

Project #	Description	Page #	Project #	Description	Page #	Project #	Description	Page #
69	Wind Charger with Sound	46	91	Solar Light Row	57	115	Solar Fun	69
70	Kick Start Motor	46	92	Crank Support	57	116	Triple Current Meter	69
71	Liquid Battery	47	93	Hand Lights	58	117	Hand Charger	70
72	Juice Battery	47	94	Hand Noise	58	118	Parallel Cranking	70
73	Cola Light	48	95	Heavy Fan	59	119	Hard to Crank	71
74	Yellow Cola	48	96	Remote Header	59	120	Slow In Flash Out	71
75	Electricity from Water	49	97	Remote Water Heater	60	121	Filling Station	72
76	Water Light	49	98	Electrical Material Checker	60	122	Gas Petal	72
77	Cola Clock	50	99	Morse Code	61	123	Volt Meter	73
78	Cola Clock with Memory	50	100	Morse Light	61	124	Anemometer	73
79	Changing Water Pressure to Electrical Pressure	51	101	Everything Circuit	62	125	Capacitor Charging	74
80	Storing Energy in Water	51	102	Motor Status LEDs	63	126	Current Summer	74
81	Hydro Lights	52	103	Energy Converter	63	127	More Current Summing	74
82	Directional Wind Lights	52	104	Energy Conversion	64	128	Summing Voltage	75
83	Emergency Transmission Loss	52	105	Small Energy Conversion	64	129	Charging Currents	75
84	Using Stored Water	53	106	Mechanical Energy Conversion	64	130	Big Resistance	76
85	Water Redirection	53	107	Generator	65	131	Little Resistance	76
86	One of the Most Powerful Forces in the Universe	54	108	Clock with Memory	65	132	Slow Charge	77
87	Electricity Against Water	54	109	Saving Energy	66	133	Funky Beeper	77
88	Harnessing Static Electricity	55	110	Energy Transmission Loss	66			
89	Solar Light Clock	56	111	Water Timer	67			
90	Solar Light Charger	56	112	Sun & Wind Light	67			
			113	Hybrid	68			
			114	Hybrid Car Concept	68			

PROJECT 1 • Hand Cranking

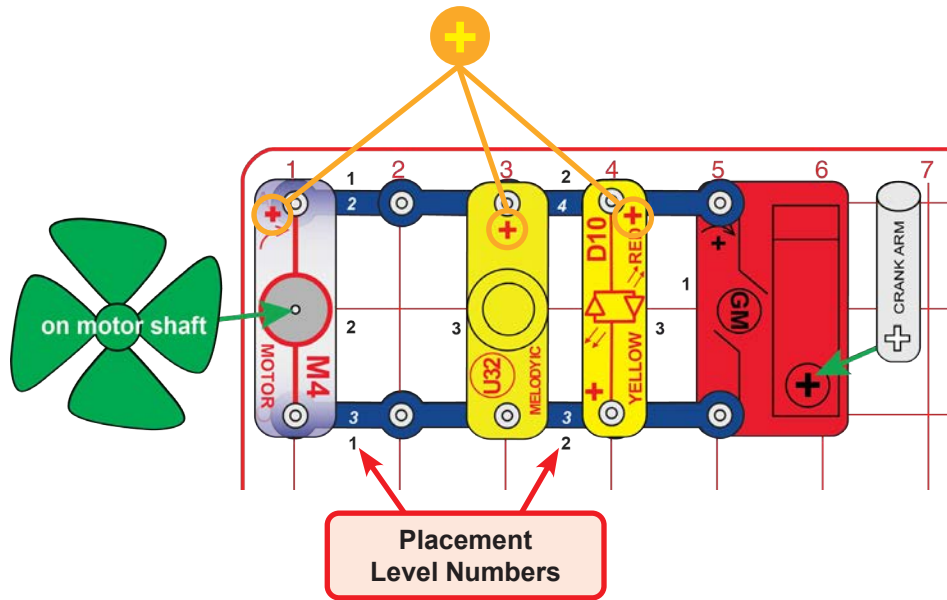

Build the circuit shown by placing all the parts with a black 1 next to them on the clear plastic base grid first. Then, assemble parts marked with a 2. Be sure to place the parts with their (+) side oriented as shown. Place the wind fan on the motor (M4) shaft, and the crank arm on the geared motor (GM). Turn the crank arm in both directions to make things happen.

Warning: the geared motor and crank arm are sturdy but not indestructible. If you push hard on it or crank it really fast you may break it.



The geared motor uses magnetism to change the mechanical energy of the spinning shaft into electricity.



PROJECT 2 • Crank Charger

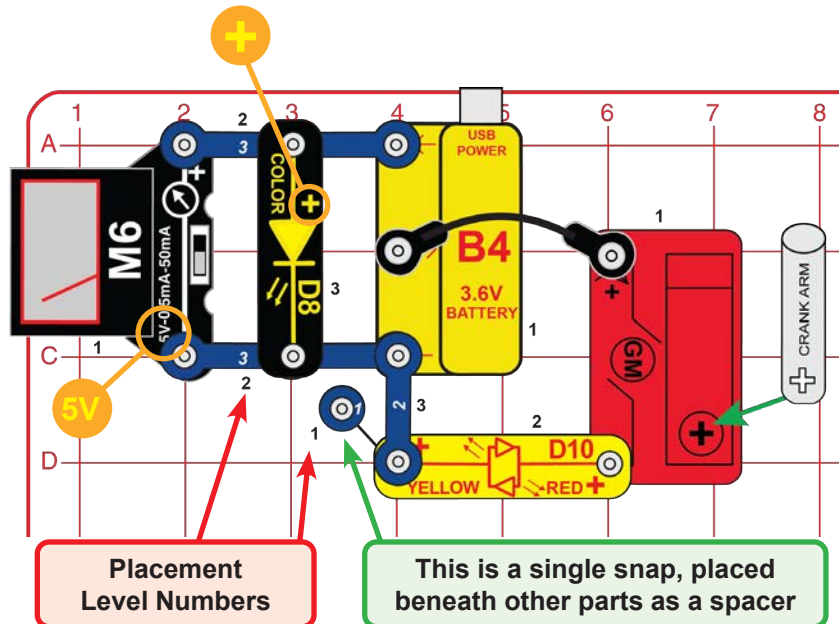

Build the circuit shown here, set the meter (M6) to the 5V setting, and place the crank arm on the geared motor (GM). The meter will measure about 3.6V if the battery is charged up.

Turn the crank arm clockwise. The red/yellow LED (D10) comes on yellow when you crank fast, indicating that the crank is charging the battery.

If the battery needs to be recharged, you can use this circuit to charge it, but you may need to crank for a long time to fully charge it.

Although the battery is rated as 3.6V, it may charge to as high as 4.0V. If you are monitoring the voltage using the meter, you may see the voltage quickly reach 3.6V, but this does not mean that the battery is fully charged. When the battery is discharging to power something, the voltage is nearly steady for a long while then drops off quickly. The same thing occurs when it is charging. Recharging the battery will quickly reach around 3.6V but it needs much more charging to avoid a quick drop-off when discharging.

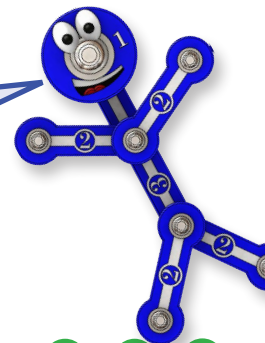

PROJECT 3 • Best Charging Circuits

Your rechargeable battery (B4) will need to be recharged often; it can be charged with a USB connection or with solar light using any of these circuits. The USB POWER light on B4 comes on when it is charging through the USB.

For solar charging, place the solar cell in sunlight or about 12 inches from an incandescent light bulb of 60W or more. It takes a few hours to charge the battery. LED, CFL, and fluorescent lights do not work well with solar cells. When measuring charge current, the current will often be too high to measure on the 0.5mA setting but too low to measure on the 50mA setting (you can use either). The current will get lower as the battery approaches full charge.

You can't hurt the battery by overcharging.

Although the battery is rated as 3.6V, it may charge to as high as 4.0V. If you are monitoring the voltage using the meter, you may see the voltage quickly reach 3.6V, but this does not mean that the battery is fully charged. When the battery is discharging to power something, the voltage is nearly steady for a long while then drops off quickly. The same thing occurs when it is charging. Recharging the battery will quickly reach around 3.6V but it needs much more charging to avoid a quick drop-off when discharging. Recharge the battery for several hours.

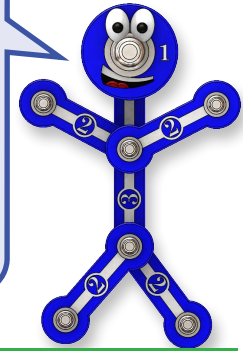

USB charging

ASSEMBLING PIVOT STAND

- 1 Place base on flat level surface.
- 2 Snap ball on pivot post into pivot top.
- 3 Insert post into base.

Angle adjustment to light source with voltage measurement:

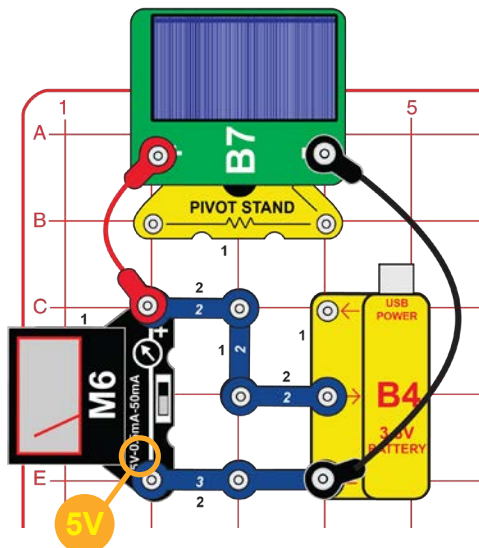

Angle adjustment to light source, measuring charge current:

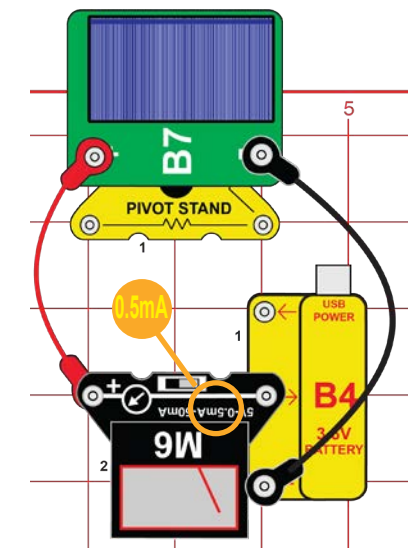

Minimum parts:

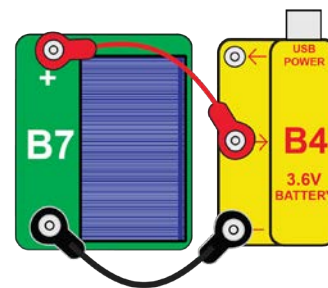

Minimum parts, measuring charge current:

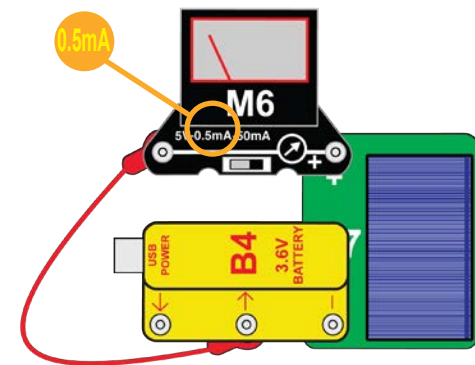

PROJECT 4 • Solar Power

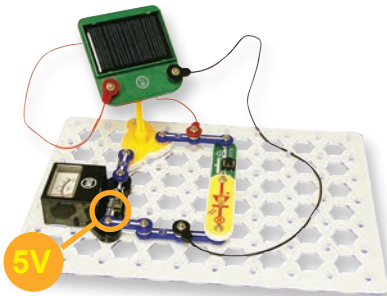
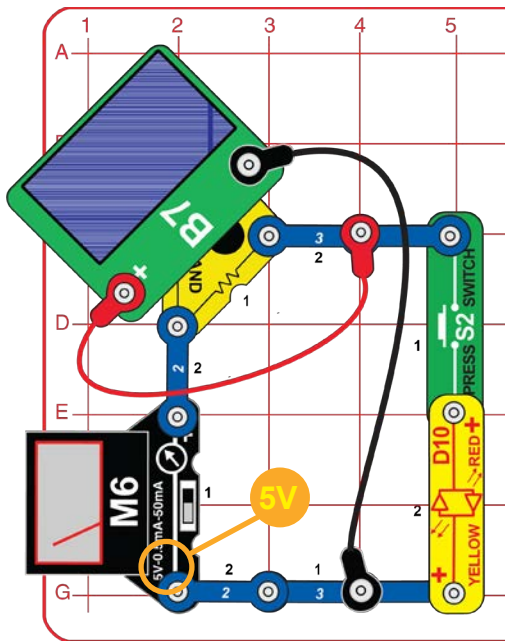

Assemble the pivot, mount the solar cell (B7) on it, and place it in the circuit as shown. Place all the parts with a black 1 next to them on the clear plastic base grid first, then parts marked with a 2. The red/yellow LED (D10) may be connected in either direction.

Connect the solar cell to the circuit using the red and black jumper wires. Place the circuit so the solar cell is in bright sunlight or close to an incandescent light bulb. Set the meter (M6) to the 5V setting.

The meter is measuring the voltage produced by the solar cell. Adjust the position of the solar cell on the pivot to see how the voltage produced changes depending on the angle to the light source and the brightness.

Position the solar cell to make the highest voltage you can. Now push the press switch to run the red/yellow LED with the solar cell. Notice how the voltage produced drops when the LED is connected.

Compare the voltage and LED brightness when using different light sources (sunlight, incandescent bulbs, LED bulbs, fluorescent bulbs) to see which work best with solar cells.

Note: The voltage produced is actually twice that shown on the meter (so a 3V reading is really 6V), because a resistor in the pivot stand is changing the scale.



Your solar cell makes electricity from sunlight, but only a small amount. In bright sunlight it produces a voltage of about 7V, but this is reduced when lots of current is flowing. That is why the voltage drops when you connect the red/yellow LED.

ASSEMBLING PIVOT STAND

- 1 Place base on flat level surface.
- 2 Snap ball on pivot post into pivot top.
- 3 Insert post into base.



PROJECT 5 • Solar Color Power

Replace the red/yellow LED (D10) with the color LED (D8, with "+" towards S2) and press the switch. See how it affects the solar cell voltage.

PROJECT 6 • Solar Motor

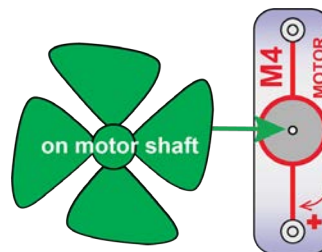

In the preceding circuit, replace the color LED (D8) with the motor (M4, in either direction) and place the wind fan on it. Now press the switch and watch how the voltage changes as the solar cell runs the fan. Depending on your light source, the fan may need a push to get started or may not work at all.



The motor needs less electricity from the solar cell as it speeds up, so the solar cell voltage is higher as the motor gets faster.

PROJECT 7 • Solar Charger 5mA

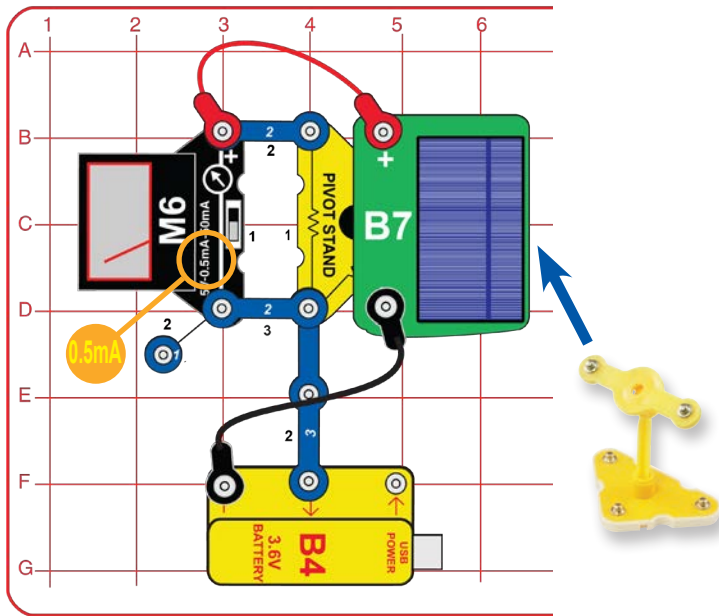

Assemble the pivot, mount the solar cell (B7) on it, and place it in the circuit as shown. Connect the solar cell to the circuit using the red and black jumper wires. Place the solar cell in sunlight or near an incandescent light bulb. The solar cell is charging the battery and the meter is measuring the current.

This circuit uses a resistor in the pivot stand to change the 0.5mA scale on the meter to a 5 mA scale, so read the current on the 0-5 scale. Charging current is usually in this range. Place your hand above the solar cell to see how easily the current changes, and try different light sources.

See project 3 if you need to recharge the battery (B4).

Solar energy is free, abundant and causes no pollution. However it is difficult to harvest because even low power solar cells are expensive.



PROJECT 8 • Long Light

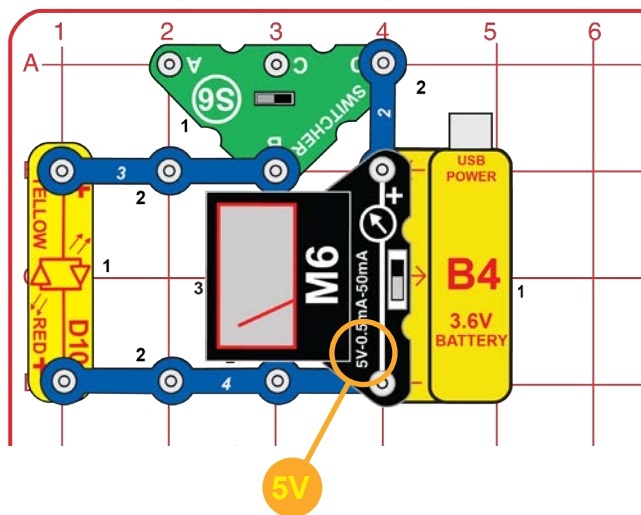

Build the circuit and set the meter (M6) to the 5V setting. Set the switcher (S6) to the right position and watch the voltage on the meter for a while as the battery runs the red/yellow LED (D10). How quickly does the voltage drop?

If your battery was recently recharged then you probably found the voltage drops very, very slowly, and thought this was boring. That was the idea - batteries can run things for a long time and (unlike solar or wind power sources) are hardly affected by changing weather conditions. Batteries can provide power whenever you need it - but, eventually, they do run out.

PROJECT 9 • Windmill

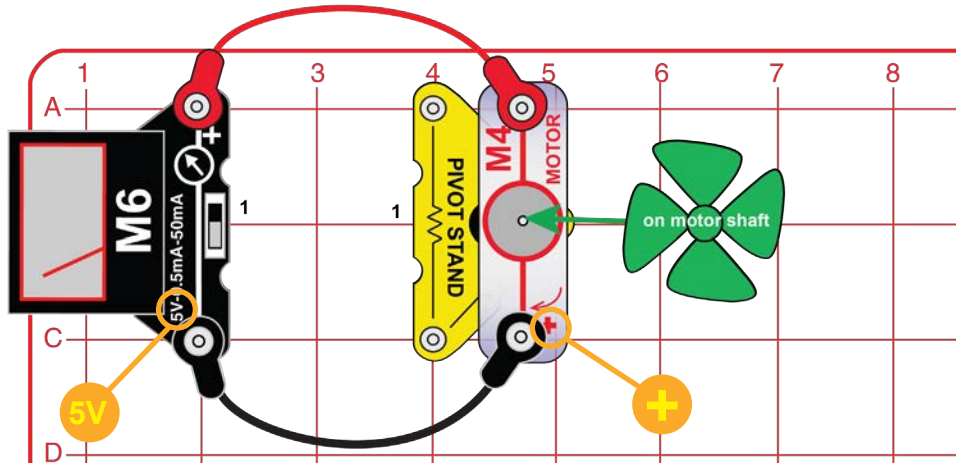

Assemble the pivot stand, mount the wind fan on the motor (M4), mount the motor on the pivot, place the pivot on the base grid and connect it to the meter (M6) using the red and black jumper wires. Set the meter to the 5V setting.

Blow on the fan or place it in a strong wind (either outside or near an electric fan). You may need to give the fan a push to get it started. The meter measures how much voltage your “windmill” produces. Adjust the pivot position to see how the voltage produced changes with the angle to the wind.

The windmill uses magnetism to change the mechanical energy of the spinning shaft into electricity. The voltage it produces is usually lower than the solar cell, but the current is higher.

ASSEMBLING PIVOT STAND

- 1 Place base on flat level surface.
- 2 Snap ball on pivot post into pivot top.
- 3 Insert post into base.

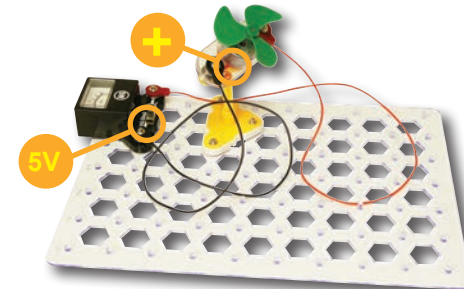

PROJECT 10 • Windy Lights

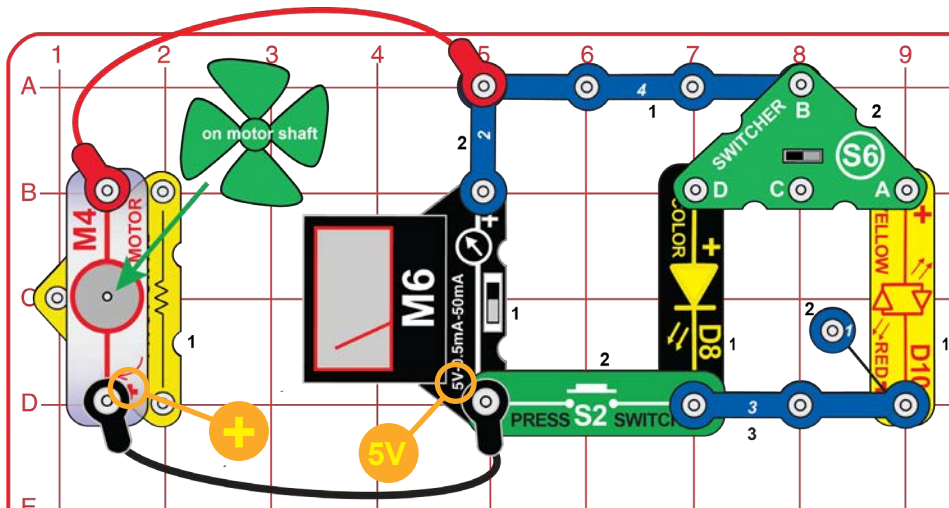

Build the circuit shown. Set the meter to the 5V setting, and the switcher (S6) to the left or right position. Blow on the fan or place it in a strong wind (either outside or near an electric fan). The meter measures how much voltage your “windmill” produces. You may need to give the fan a push to get it started.

Push the press switch (S2) to connect one of the LEDs (D8 & D10) to the windmill. The voltage produced drops a little, but not as much as for the solar cell circuits. Flip the switcher to the other side to try the other LED. Compare the brightness of the LEDs at different wind speeds.

PROJECT 11 • Multi Power

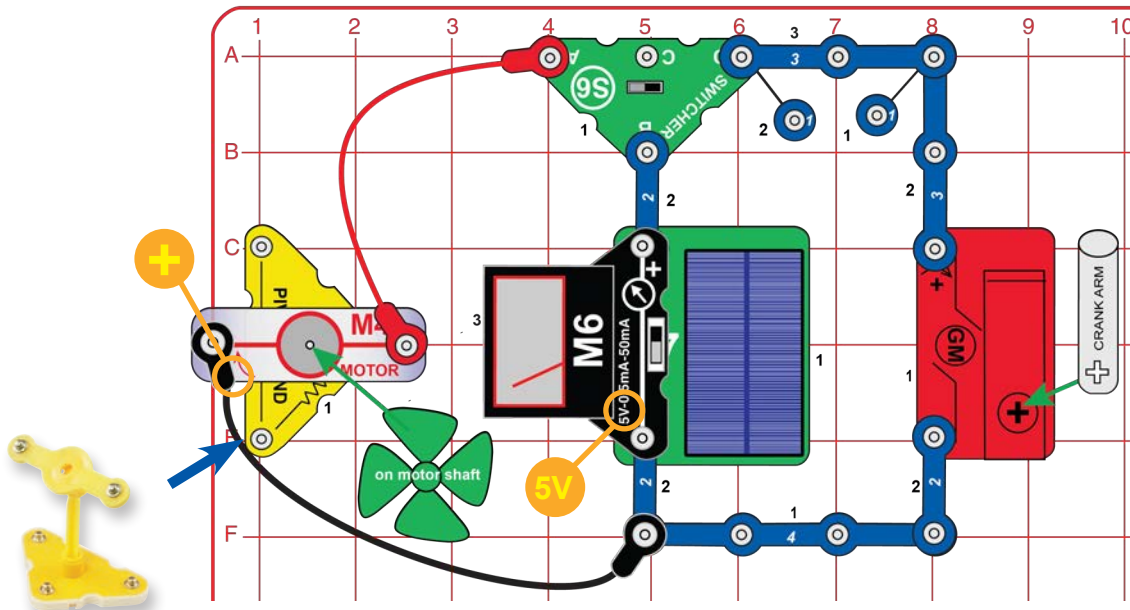

Build the circuit shown and set the meter to the 5V setting. Set the switcher to the middle position and the meter measures the voltage produced by the solar cell. Next, set the switcher to the left position and blow on the windmill to see the voltage it produces. Next, set the switcher to the right position and turn the crank arm to see the voltage it produces.

You can change the meter setting to 50mA, to measure the current produced.

The switcher is used to prevent the windmill and hand crank from interfering with each other and the solar cell.

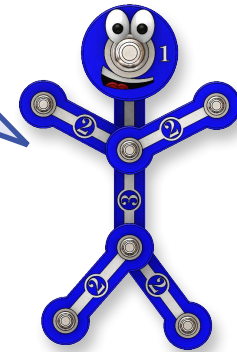

PROJECT 12 • Battery Power

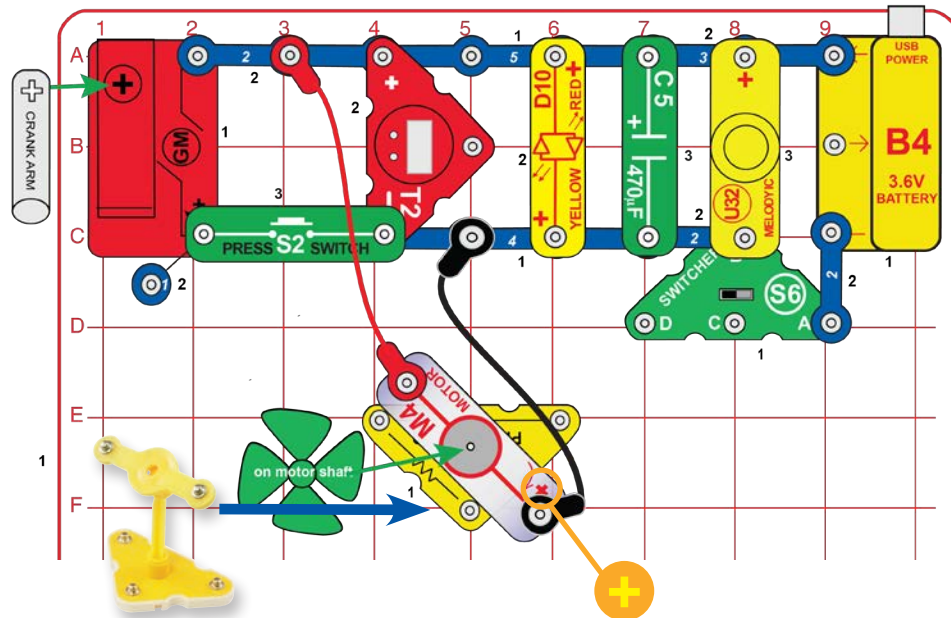

Make sure the battery is charged up (see project 3). Build the circuit with the motor and fan on the pivot stand, and connect the jumper wires as shown. Set the switcher (S6) to the right position to turn on the circuit. The battery runs the clock display (T2), melody IC (U32), red/yellow LED (D10), and windmill (M4). Push the press switch (S2) and the crank arm on the geared motor (GM) will also spin.

Part B: Set the switcher to the left or middle position to disconnect the battery, and blow on the fan or place it in a strong wind. See if your “windmill” will run things as well as the battery, and for how long.

Part C: Leave the switcher at the left or middle position and push the press switch while turning the crank arm to see how well it runs things. Try cranking it in both directions.

See project 3 if you need to recharge the battery (B4).

This battery can store lot of energy, so it can run lots of things for a while. It is available whenever you need it, at the flip of a switch.



PROJECT 13 • Wind Warning

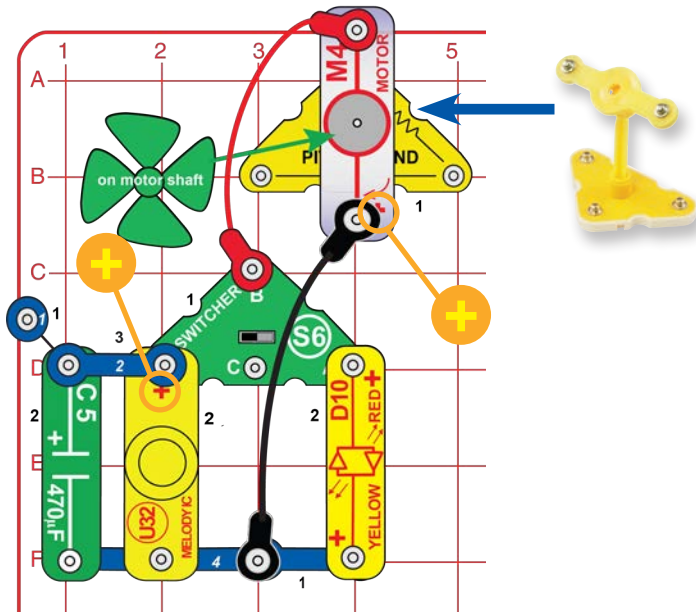

Build the circuit as shown, with the motor on the pivot stand. Set the switcher (S6) to the left for sound (in one wind direction) or to the right for light. Blow on the fan, place it in a strong wind, or give it a good spin with your fingers. The fan must spin very fast to produce sound.

This circuit can be used to warn you of dangerous winds.

PROJECT 14 • Light Charger

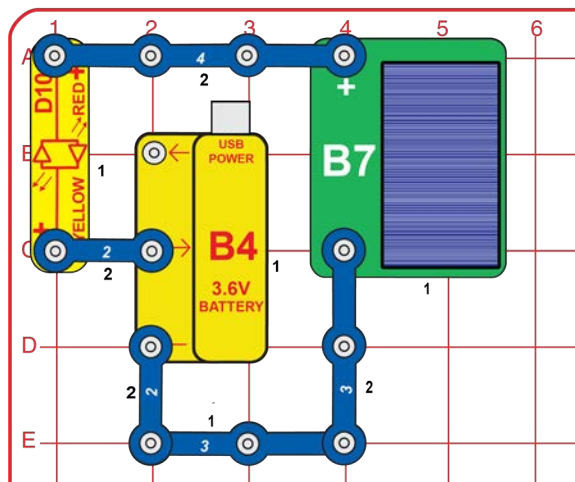

This circuit uses the solar cell (B7) to charge the rechargeable battery (B4). Place the solar cell in sunlight or near an incandescent light bulb. The red/yellow LED (D10) lights red when the battery is being charged. The brighter the LED, the faster it is charging.

Build the circuit shown and push the press switch (S2) to turn on the red LED (D10).

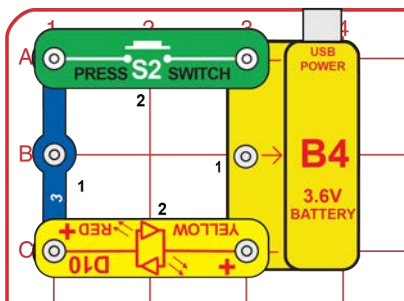

See project 3 if you need to recharge the battery (B4).

Educational Corner:

What is really happening here?



1. The battery (B4, containing a 3.6V rechargeable battery with protection circuitry) converts chemical energy into electrical energy and “pushes” it through the circuit, just like the electricity from your power company. A battery pushes electricity through a circuit just like a pump pushes water through a pipe.
2. The snap wires (the blue pieces) carry the electricity around the circuit, just like wires carry electricity around your home. Wires carry electricity just like pipes carry water.
3. The press switch (S2) controls the electricity by turning it on or off, just like a light switch on the wall of your home. A switch controls electricity like a faucet controls water.
4. The red/yellow LED (D10, a “light emitting diode”) converts electrical energy into light; it is similar to lights in your home. An LED shows how much electricity is flowing in a circuit like a water meter shows how fast water flows in a pipe.
5. The base grid is a platform for mounting the circuit, just like how wires are mounted in the walls of your home to control the lights.

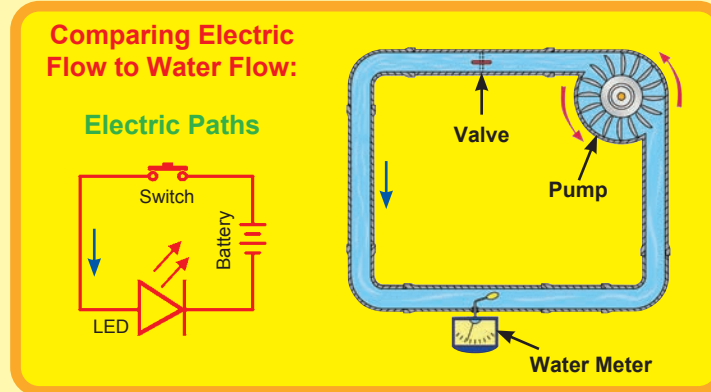
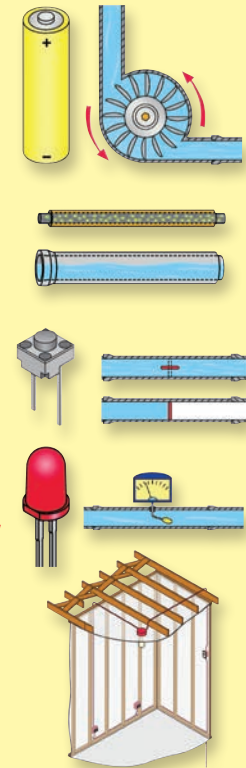

PROJECT 16 • Close the Door

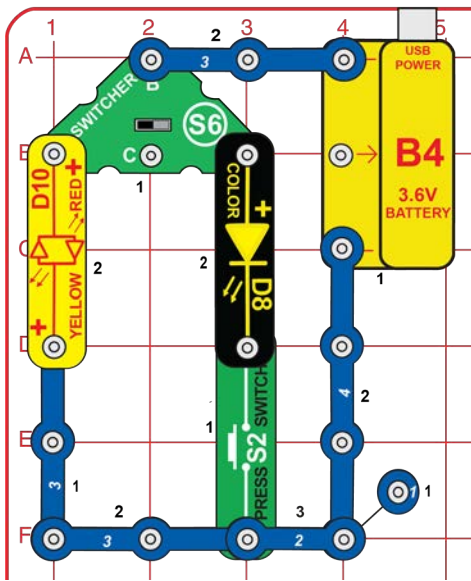

Build the circuit shown. The switch (S6) and press switch (S2) control the lights.

See project 3 if you need to recharge the battery (B4).

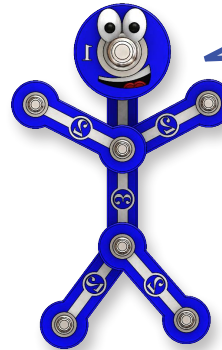

The “on” position of a switch is also called the “closed” position. Similarly, the “off” position is also called the “open” position. This is because the symbol for a simple switch is similar to the symbol for a door in an architect’s drawing of a room:

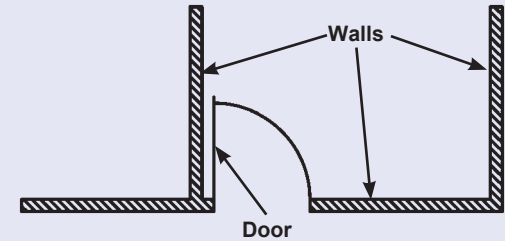

The electronics symbol for a simple switch should be thought of as a door to a circuit, which swings open when the switch is off. The “door” to the circuit is closed when the switch is on. This is shown here:

As used in this circuit your S6 switch has 3 positions, so it has a different symbol:

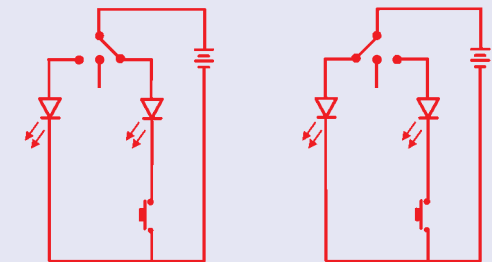
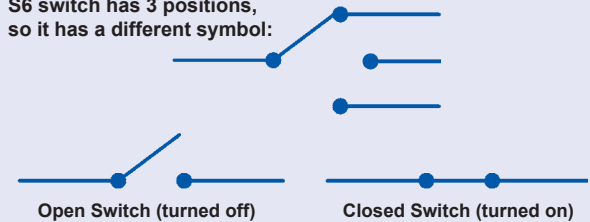

Left Switch Position Open (turned off)
Right Switch Position Closed (turned on), right LED controlled by press switch

Left Switch Position Closed (turned on)
Right Switch Position Open (turned off)

PROJECT 17 • Feeling Switchy

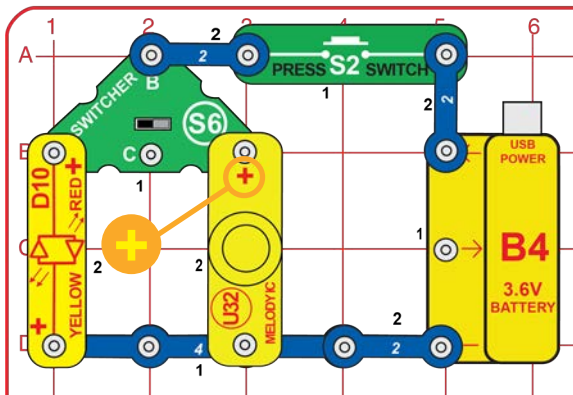

Build the circuit shown and push the press switch (S2) to turn on light or sound. Switches can be arranged in many different ways.

The press switch allows electricity to flow from the battery to the circuit and the switcher (S6) directs the electricity to the red LED (D10) or the melody IC (U32). These switches are like many switches in your home, controlling lights and many other things.



PROJECT 18 • Reverser

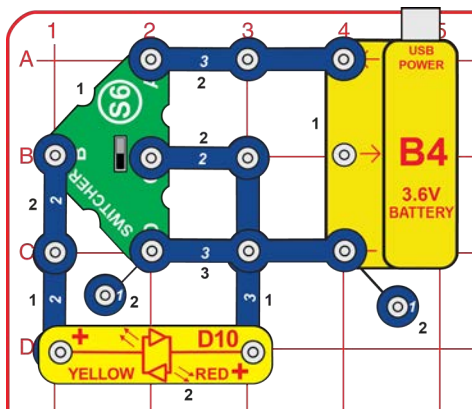

Build the circuit shown. Use the switcher (S6) to control the light.

See project 3 if you need to recharge the battery (B4).



The switcher (S6) is actually a complex switch used to reverse the wires to a component or circuit. Its connections look like this:

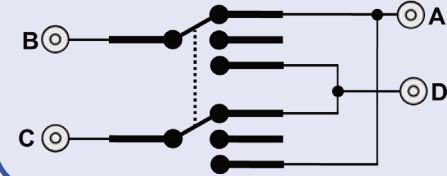

PROJECT 19 • Super Reverser

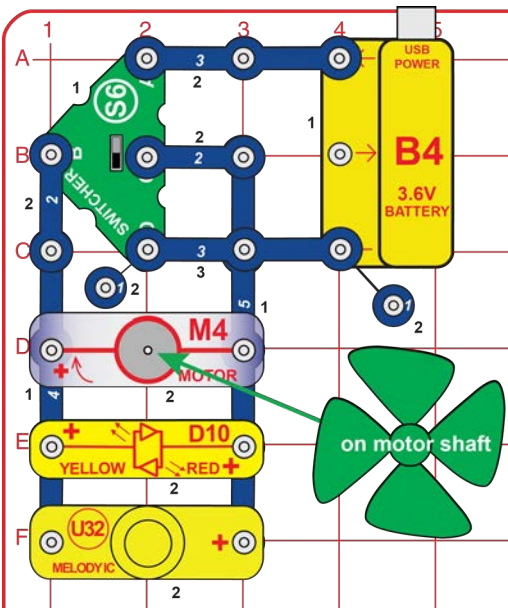

Modify the preceding circuit to be this one. Use the switcher (S6) to control light, sound, and motion. The melody IC (U32) only works in one direction.

You can replace any of the motor (M4), red/yellow LED (D10), or melody IC with the color LED (D8), clock (T2), or geared motor (GM).

See project 3 if you need to recharge the battery (B4).

PROJECT 20 • Voltage

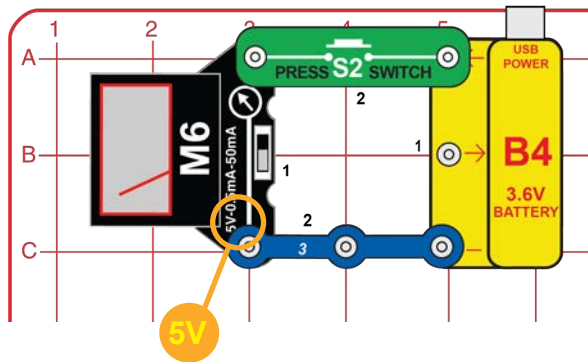

See project 3 if you need to recharge the battery (B4).

Build the circuit shown. Set the meter (M6) to the 5V setting. Push the switch (S2) to connect the meter to the battery and measure its voltage.

Electricity is the movement of sub-atomic charged particles (called **electrons**) through a material due to electrical pressure across the material, such as from a battery.

The electrical pressure exerted by a battery or other power source is called **voltage** and is measured in **volts** (V). Notice the “+” and “-” signs on the battery. These indicate which direction the battery will “pump” the electricity.

Circuits need the right voltage to work properly. For example, if the voltage to a light bulb is too low then the bulb

won't turn on; if too high then the bulb will overheat and burn out.

The **electric current** is a measure of how fast electricity is flowing in a wire, just as the water current describes how fast water is flowing in a pipe. It is expressed in **amperes** (A) or **milliamperes** (mA, 1/1000 of an ampere).

The **“power”** of electricity is a measure of how fast energy is moving through a wire. It is a combination of the voltage and current (Power = Voltage x Current). It is expressed in **watts** (W).



PROJECT 21 • Resistors

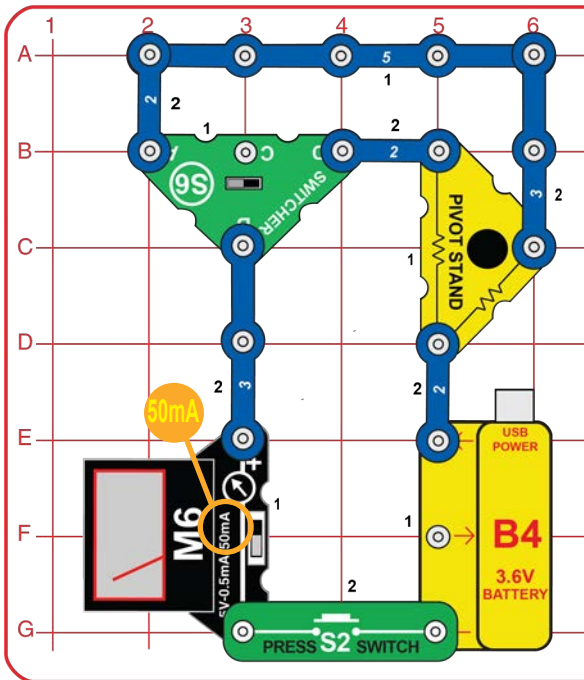

Build the circuit shown. Set the meter (M6) to the 50mA setting and the switcher (S6) to the right position. The pivot stand base has 47W and 10KW resistors in it. They are used to control the flow of electricity in a circuit.

Push the press switch (S2) to measure the current through the 47W resistor; it should be around 50mA.

To measure the current through the 10KW resistor, set the meter to the 0.5mA setting and the switcher to the left position. Push the press switch to show the current, it should be around 0.4mA. The current is much lower this time, because the 10KW is a higher value resistor.

The meter has internal resistors, which scale the measurement it makes into the ranges indicated on it. The 10KW resistor can be used with it to double the voltage scale to 10V. Keep the switcher in the left position, set the meter to the 5V setting, and push the press switch to measure the battery voltage using a 10V scale (double what you read on the 5V scale).

The **resistance** of a circuit represents how much it resists the electrical pressure (voltage) and limits the flow of electric current. The relationship is Voltage = Current x Resistance. When there is more resistance, less current will flow unless you increase the voltage. Resistance is measured in ohms (Ω), or kilo ohms (K Ω , 1000 ohms).

What is Resistance? Take your hands and rub them together very fast. Your hands should feel warm. The friction between your hands converts your effort into heat. Resistance is the electrical friction between an electric current and the material it is flowing through; it is the loss of energy from electrons as they move through the material.



PROJECT 22 • Light Emitting Diode

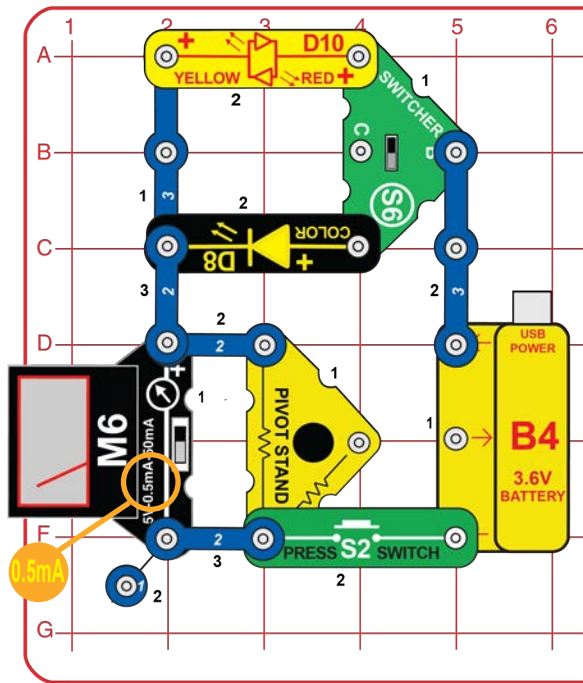

Build the circuit shown. Set the meter (M6) to the 0.5mA setting.

For the upper and lower switcher (S6) positions, push the press switch (S2) to measure the current through one of the LEDs (D8 & D10). Then change the switcher to measure the current with the other LED, and compare them. The current for D8 changes as it changes colors.

Note: The 0.5mA meter scale is actually a 5mA scale due to a resistor in the pivot stand being used to scale the current. Change the meter to the 50mA setting and compare the measurement there (the pivot stand resistor will have little effect on the 50mA meter scale).

Light emitting diodes (LEDs) are one-way lights with a turn-on voltage threshold. If the voltage is high enough (about 1.5V for red or yellow, about 2V for green, and about 3V for blue), they will light. Once an LED is activated, current must be limited by other components in the circuit or the LED can be damaged; your D8 and D10 LEDs have 330Ω internal resistors added to protect them.

When electric current flows through an LED, energy is released as light; the color depends on the material. LEDs are much more energy efficient and last longer than ordinary incandescent light bulbs but originally were only used in low-power applications due to power limits, cost, and limited colors. LEDs have since been improved and are now widely used in home lighting.

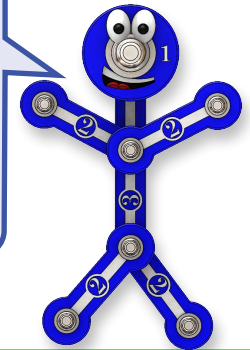

PROJECT 23 • Play a Tune

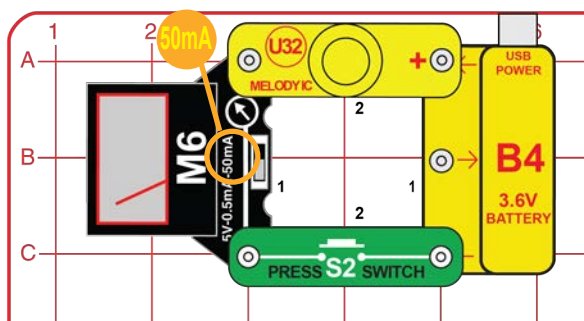

Build the circuit, set the meter (M6) to the 50mA setting. Push the switch (S2) to play a tune on the melody IC (U32), while the meter measures the current through it.

Compare the current with the melody IC to the current using the LEDs and resistors in projects 21 and 22.

See project 3 if you need to recharge the battery (B4).

The melody IC converts electricity into sound energy by making mechanical vibrations. These vibrations create variations in air pressure, which travel across the room. You “hear” sound when your ears feel these air pressure variations.

The current is higher when the sound is louder, because it takes more electrical energy to produce more sound.



PROJECT 24 • Clock

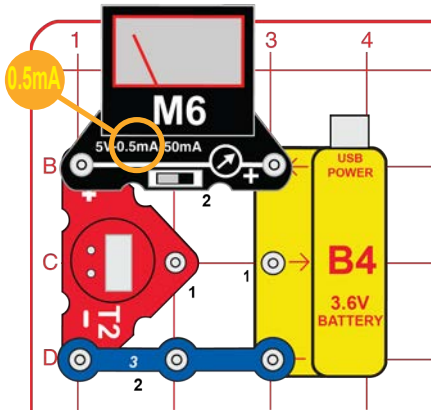

Build the circuit shown. Set the meter (M6) to the 0.5mA setting. The clock display will light, but the meter will not measure any current. See page 4 if you would like to set the time.

The clock needs only about 0.005mA of current to operate, and this is too small to measure on your meter. The battery can run the clock for a long time without being recharged.

See project 3 if you need to recharge the battery (B4).

The clock uses a liquid display (LCD) to show the time. LCDs use very little power, but cannot be viewed in darkness. The electronic circuitry that keeps time, controls the display and allows you to set the current time is complex but has been miniaturized in an integrated circuit (IC).



PROJECT 25 • Capacitor

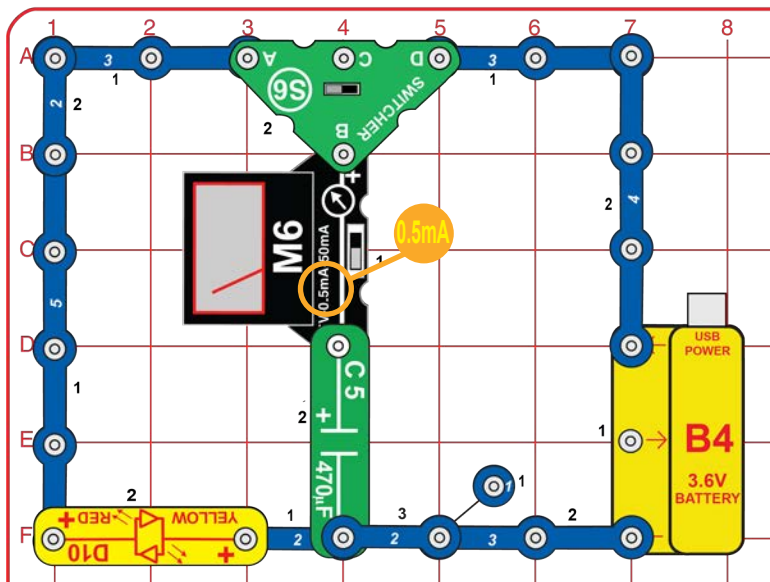

Build the circuit shown. Set the meter (M6) to the 0.5mA setting. Flip the switcher (S6) back and forth between its left and right positions to charge and discharge the 470mF capacitor (C5).

With the switcher set to the right, a electricity briefly flows from the battery into the capacitor to charge it up, as shown by the meter. With the switcher set to the left, the energy in the capacitor discharges through the red LED (D10), which flashes.

The meter only measures current in one direction, but you can flip it around to measure the discharge current.

Capacitors store electricity in an electric field between metal plates, with a small separation between them. This electric field is similar to the magnetic field of a magnet. Compared to batteries (which store energy as separated chemicals), capacitors can only store small amounts of energy, but they can release it quickly, can be made in very small sizes and are inexpensive.



PROJECT 26 • Motor

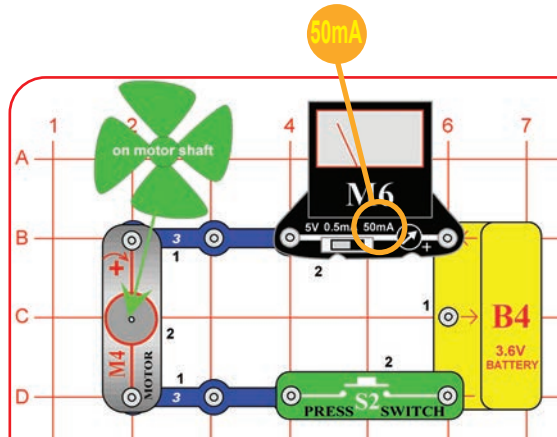

Build the circuit shown. Set the meter (M6) to the 50mA setting and place the wind fan on the motor (M4). Push the press switch (S2) and watch the current on the meter as the motor speeds up.

Do you know why the current drops as the fan speeds up?

See project 3 if you need to recharge the battery (B4).

How does electricity turn the shaft in the motor? The answer is magnetism. Electricity is closely related to magnetism and an electric current flowing in a wire has a magnetic field similar to that of a very, very tiny magnet. Inside the motor is a coil of wire with many loops. If a large electric current flows through the loops, the magnetic effects become concentrated enough to move the coil. The motor has a magnet inside, so as the electricity moves the coil to align it with the permanent magnet, the shaft spins.



PROJECT 27 • Water Wheel

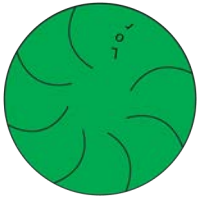

Remove the wind fan from the motor shaft and replace it with the water wheel. Watch how the current is different with the larger water wheel.

The water wheel is heavier, so it takes more current to spin it, and doesn't get as fast. Try laying something on the water wheel to give it even more weight.

PROJECT 28 • Motor Voltage

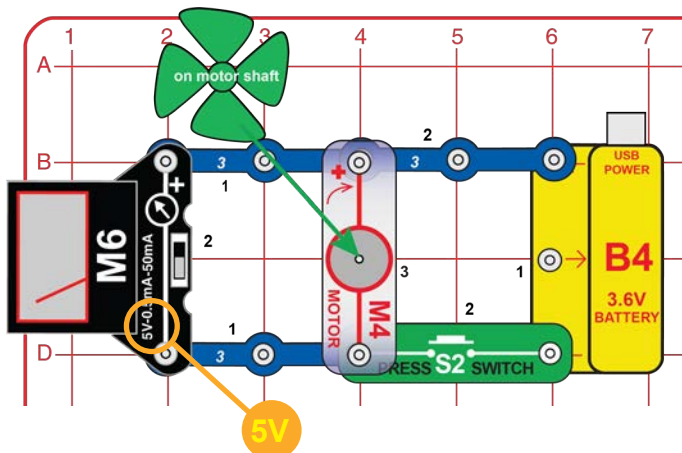

Modify the preceding circuit into this one. Set the meter (M6) to the 5V setting and place the wind fan on the motor (M4). Push and release the press switch (S2) and watch the voltage on the meter as the motor speeds up and slows down.

Without pressing the switch, spin the fan clockwise with your finger and watch the voltage. In the preceding project, the current dropped as the fan sped up - now you see why. The spinning fan produces a voltage in the motor; this voltage opposes the voltage from the battery, reducing the current as the motor speeds up.

How will the voltage and current change if you replace the wind fan with the water wheel? Try it.

Electricity is generated when you spin the motor shaft. A coil of wire is on the shaft and as it spins past the permanent magnet an electric current is created in the wire.



PROJECT 29 • Crank Motor

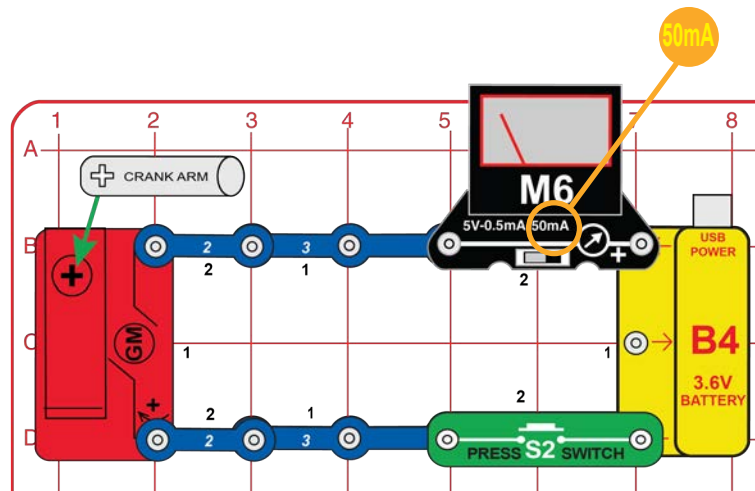

Build the circuit shown. Set the meter (M6) to the 50mA setting. Push the press switch (S2) and watch the current on the meter when the crank arm on the geared motor (GM) spins.

Replace the geared motor with the motor (M4) and wind fan, red/yellow LED (D10), color LED (D8, "+" on top), or melody IC (U32, "+" on top) and compare the current measured on the meter.

See project 3 if you need to recharge the battery (B4).

The geared motor is a motor with a gearbox attached. The gearbox spins the crank handle slower but with more force than when the motor shaft is spinning.

The slow-spinning crank handle may look boring compared to the fast wind fan on the M4 motor, but using a gearbox allows a low-power motor to move heavier objects than they normally could.

It takes more power to run the geared motor than the other devices, so the current with it will be higher.



PROJECT 30 • Crank Motor Voltage

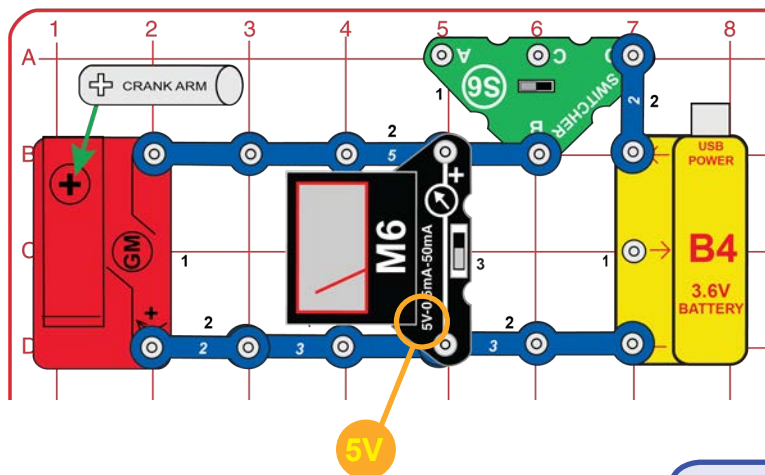

Modify the preceding circuit into this one. Set the meter (M6) to the 5V setting. Set the switcher (S6) to the right position and watch the voltage on the meter when the crank arm spins.

Set the switcher to the left or middle position to disconnect the battery. Turn the crank arm counter-clockwise and see how much voltage you generate. You can switch the meter to the 50mA setting to see how much current you produce when you spin the fan.

Set the meter back to the 5V setting and the switcher back to the right position. While it is spinning, CAREFULLY AND WITHOUT USING MUCH FORCE, try to turn the crank handle in both directions. Feel how much easier or harder it is to turn the crank when the battery voltage is helping or opposing you. USING EXCESSIVE FORCE MAY DAMAGE THE HAND CRANK!

The motor in the geared motor is different from the M4 motor, but similar. Did you see how much more voltage and current you can generate using the hand crank than with the M4 motor?

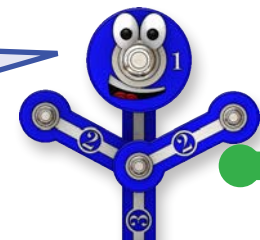

PROJECT 31 • Fade Out

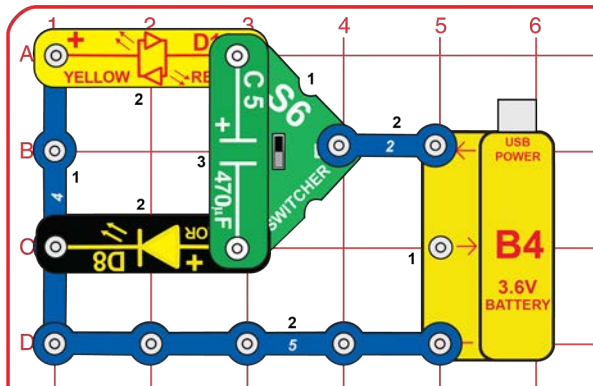

Set the switcher (S6) to the top or bottom position. Watch as one LED fades out after a few seconds, then set the switcher to the other side. Do this several times.

The 470mF capacitor (C5) stores electricity, and keeps the disconnected LED on for a few seconds after you flip the switch.



PROJECT 32 • Mini Car with Wired Control

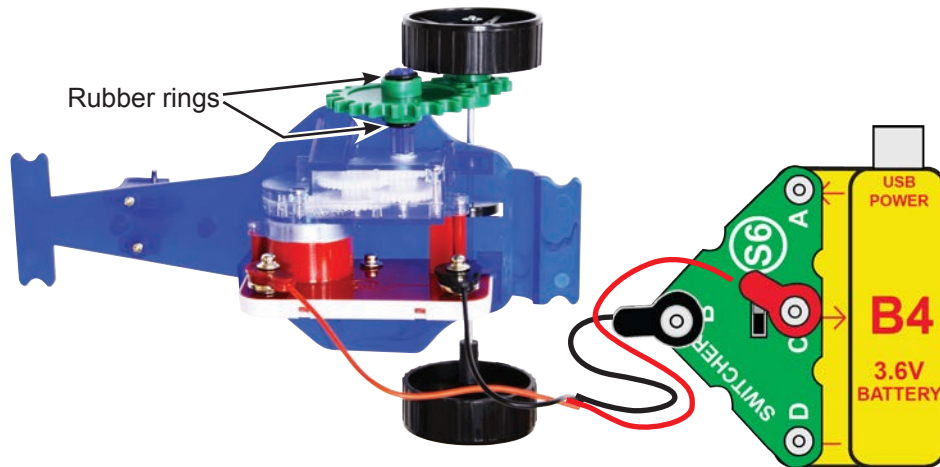

Build the circuit as shown, initially setting the switcher (S6) to the middle setting. Mount the 1.75" gear on the geared motor (GM) with the rubber rings to keep it from sliding out of position, place it on the mini car frame, and connect it to the circuit using the red & black jumper wires. Now use the switcher to make the mini car go forward, backward-turning, or stop. You can follow the car around the room or table while using S6 to control it. Be careful to follow it closely so you don't over-extend the jumper wires, and to keep it from falling off the table.

See project 3 if you need to recharge the battery (B4).

PROJECT 33 • Wired Control Car with Light/Sound



Modify the preceding circuit to include the red/yellow LED (D10) and melody IC (U32), mounted on the car using two 2-snap wires. A tune plays and the LED lights yellow when the car is going forward, or the LED lights red when the car goes backward-turning.

PROJECT 34 • Mini Car with on-Board Control

Side view:

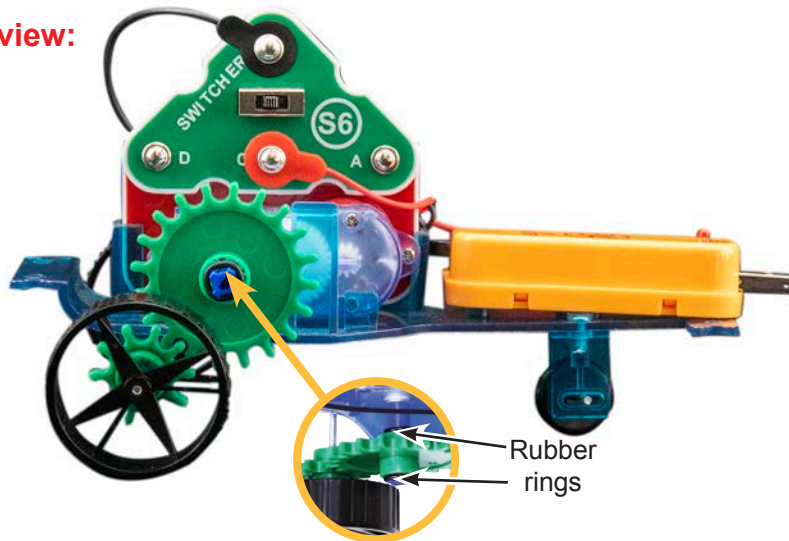

Top view:

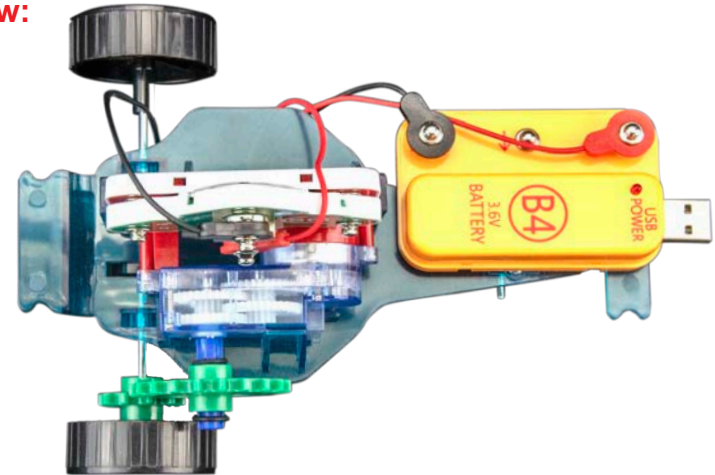

Build the circuit as shown, initially setting the switcher (S6) to the middle setting. Mount the 1.75" gear on the geared motor (GM) with the rubber rings to keep it from sliding out of position, place it on the mini car frame, and connect the battery (B4), switcher (S6) and red & black jumper wires as shown. Use the switcher to make the mini car go forward, backward-turning, or stop.

The battery may not be able to drive this mini car for long without recharging, so connect it to a USB port to recharge it as needed (it can also be recharged using the solar cell as shown in project 3).

Variant A: Monitor the battery voltage by setting the meter (M6) to the 5V setting and place it on the ends of the red & black jumper wires that are on the battery. Disconnect the meter when you are not using the set because the meter will gradually drain the battery.

Variant B: Instead of the meter, place the clock (T2) over the battery using two 1-snap wires, clock (+) to battery (←). See page 4 if you would like to set the time.

Many cars on our roads are now powered using batteries and electricity instead of gasoline. This mini car is like one of today's electric cars, with the B4 rechargeable battery representing the car battery and the USB charger representing charging an electric car battery using your house electricity or at electric car charging station.



PROJECT 35 • Mini Car with on-Board Light

Side view:



Top view:



Add the red/yellow LED (D10) to the preceding circuit using two 1-snap wires and two 2-snap wires, as shown. The LED lights yellow when the car is going forward, or red when it goes backward-turning.

You can replace the red/yellow LED with the color LED (D8), but the color LED only lights in one car direction.

PROJECT 36 • Mini Car with on-Board Sound

Side view:



Top view:

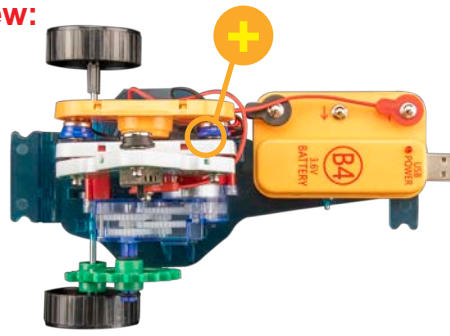

Use the project 34 circuit but add the melody IC (U32) using two 1-snap wires, as shown. A tune plays when the car moves backward. You can reverse the orientation of the melody IC to make the sound play when the car moves forward.

PROJECT 37 • Mini Car with Light & Sound

Side view:



Top view:

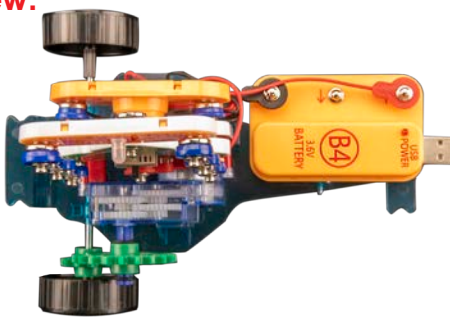

Use the preceding circuit but add the red/yellow LED (D10) using two 3-snap wires, as shown.

PROJECT 38 • Mini Car with Solar Charger

Top view:

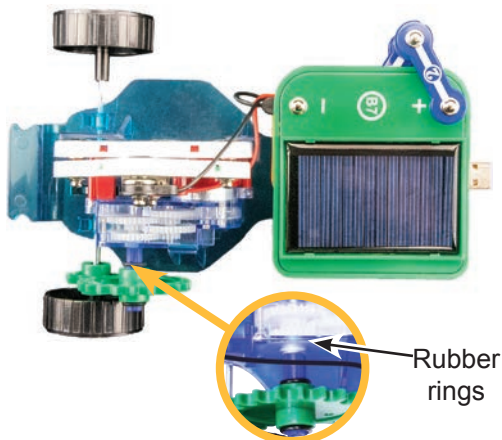

Front view:



Use the project 34 circuit but add the solar cell (B7) using two 1-snap wires and three 2-snap wires, as shown. Sunlight or incandescent lights can recharge the battery.

CIRCUIT DRAWING:

Side mounted:

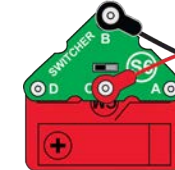

On front of car:

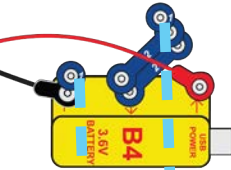

Over battery:

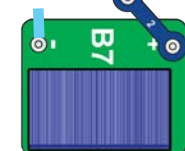

PROJECT 39 • Fan Car

Build the circuit as shown, initially setting the switcher (S6) to the middle setting. Mount the 1.75" gear on the geared motor (GM) with the rubber rings to keep it from sliding out of position, place it on the mini car frame, and connect the battery (B4) and other parts as shown. Use the switcher (S6) to make the mini car go forward, backward-turning, or stop. The fan spins when the car is moving.

See project 3 if you need to recharge the battery (B4).

CIRCUIT DRAWING:

Side mounted:

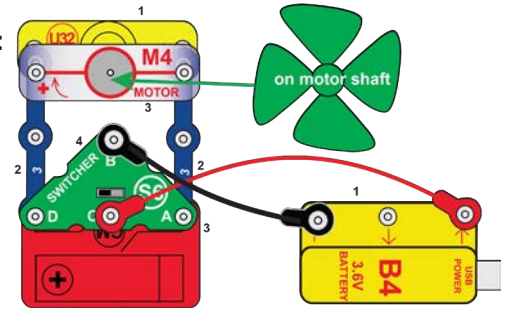

B4 on front of car.

Side view:

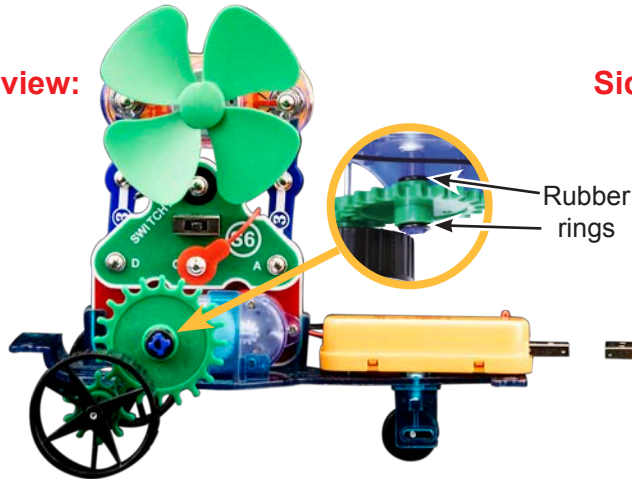

Side view:

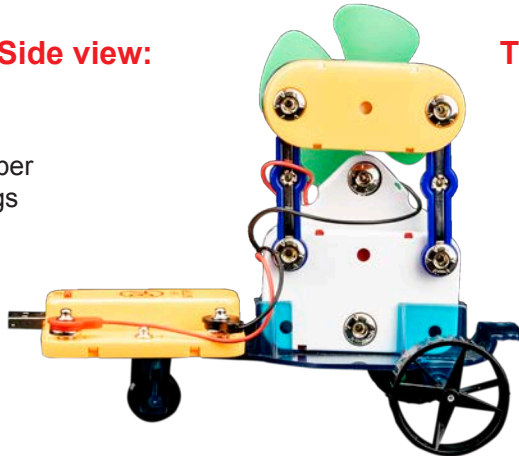

Top view:

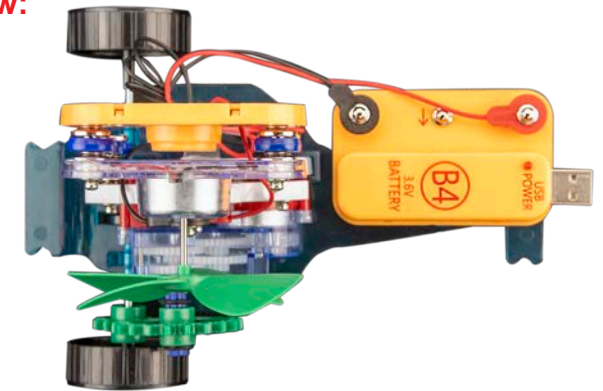

PROJECT B1 • BONUS: Light Activated Car

Side view:



Top view:



This project requires some parts not included in this set, but which you may already have from other Snap Circuits® sets.. Mount the 1.75" gear on the geared motor (GM) with the rubber rings to keep it from sliding out of position, place it on the mini car frame, and connect the battery (B4), color LED (D8), two 1-snap wires, one 2-snap wire, a PNP transistor (Q1, not included), a phototransistor (Q4, not included; a photoresistor (RP) may be used instead), and red & black jumper wires as shown. Shine a bright light on the phototransistor (or photoresistor) to make the car go forward.

You can swap the red & black jumper wire connections to the geared motor (GM) to make the car go backward-turn instead of forward.

The battery may not be able to drive this mini car for long without recharging, so connect it to a USB port to recharge it as needed (it can also be recharged using the solar cell as shown in project 3).

Parts required from other Snap Circuits® sets:
 PNP transistor (Q1)
 phototransistor (Q4) or photoresistor (RP)

CIRCUIT DRAWING:

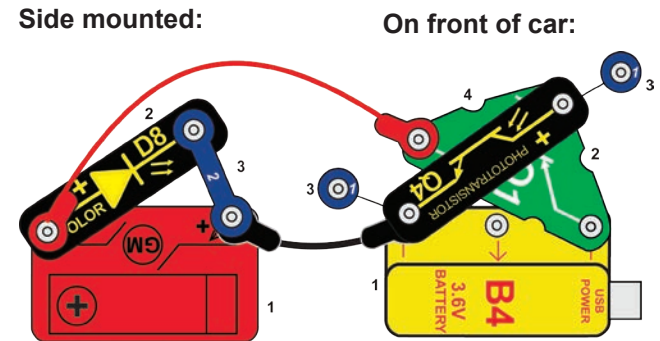

PROJECT 40 • LED Currents

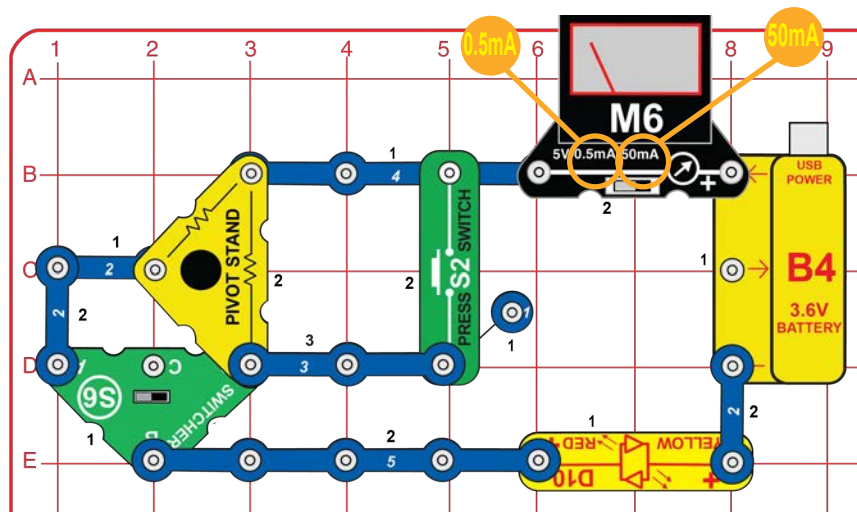

Build the circuit, set the switcher (S6) to the left position, and set the meter (M6) to the 0.5mA setting. This circuit has the red/yellow LED (D10) in series with a 10KW resistor in the pivot stand. 10KW is a high resistance, so the meter measures a small current and the LED is dimly lit. It is easier to see the LED if you take the circuit into a dark room. If the LED does not light at all then the battery needs to be recharged.

Switch the meter to the 50mA setting. Now set the switcher to the right position, replacing the 10KW resistor with a smaller 47W resistor in the pivot stand. The LED is brighter now and the current is higher. The current is not as high as you might have expected with only a 47W resistor in series with the LED, because the LED has a 330W resistor hidden inside to protect it from possible overloading, so the total resistance in series with the LED is actually $47W + 330W = 377W$.

Now push the press switch to bypass the 47W resistor in the pivot stand. The current and LED brightness are slightly higher now since only the LED's 330W internal resistor remains in the circuit.

Flip the red/yellow LED around to its yellow side or replace it with the color LED (D8, "+" on left) and see how the brightness and current change.

Adding resistors to a circuit is like partially blocking a water pipe, reducing the flow of water.

High currents can damage LEDs, so resistors are usually used with them to limit the current. Your D8 and D10 LEDs have internal resistors of around 330W to protect them.

PROJECT 41 • Battery Load

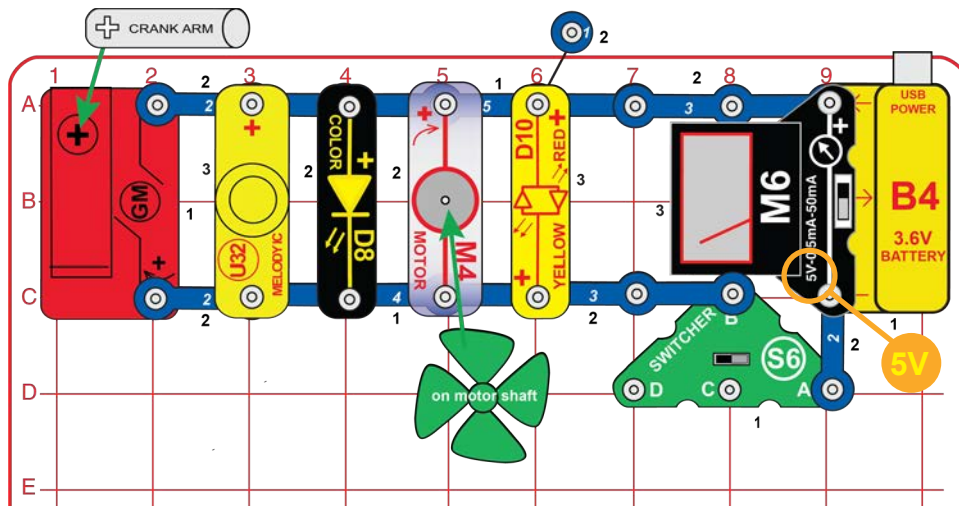

Build the circuit and set the meter (M6) to the 5V setting. Set the switcher (S6) to the left or middle position (off) and read the battery (B4) voltage when it is not running anything.

Now set the switcher to the right position and see what happens to the voltage when everything turns on. If the battery is already weak, some modules may not start. If you watch the voltage for a while, you will see it slowly drop as the battery is discharged. If the battery was already weak, the voltage will drop faster.

If you remove some of the devices the battery is running (the LEDs, melody IC, motor, and geared motor), then the voltage will not drop as much when the switcher is turned on.

See project 3 if you need to recharge the battery (B4).

The battery makes electricity using a chemical reaction, but has a limited amount of chemicals and not all of it can react at the same time. When a battery cannot supply as much current as a circuit needs, the voltage (electrical pressure) drops. That is why the voltage drops when the switch connects the battery to the rest of this circuit.

Engineers refer to all the devices a power source is running as the load, because they are the burden the power source is carrying.



PROJECT 42 • Battery Load Current

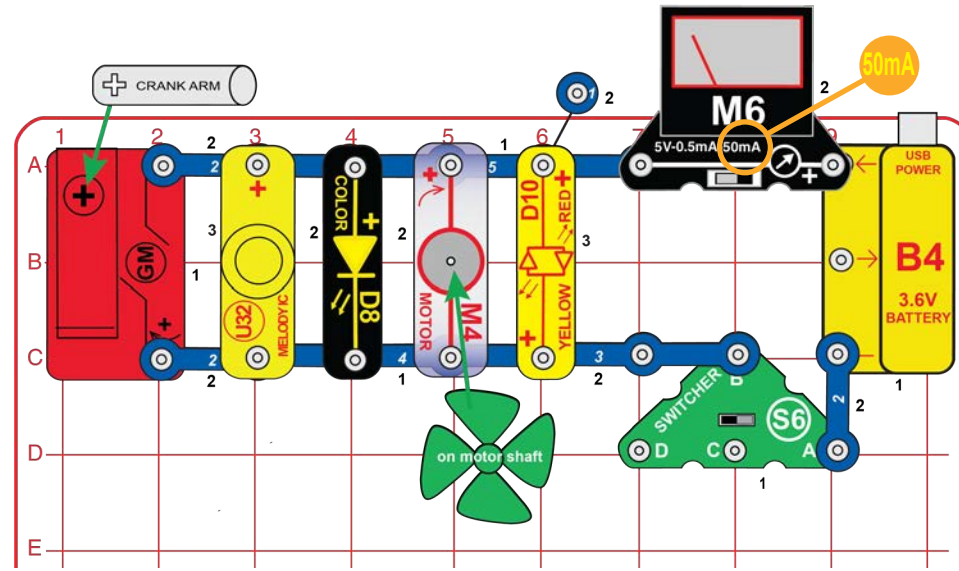

Move the meter to the new location shown and set the meter (M6) to the 50mA setting. Set the switcher (S6) to the right position and see how high the current is when the battery is running all these devices.

You may see that the current is very high, which explains why the battery voltage dropped in the preceding project. Do you know which devices need most of the current? Remove some and see how the current changes to see if you were right.

Your M6 meter is a simple meter, don't expect it to be as accurate as normal electronic test instruments.



PROJECT 43 • Make Your Own Parts

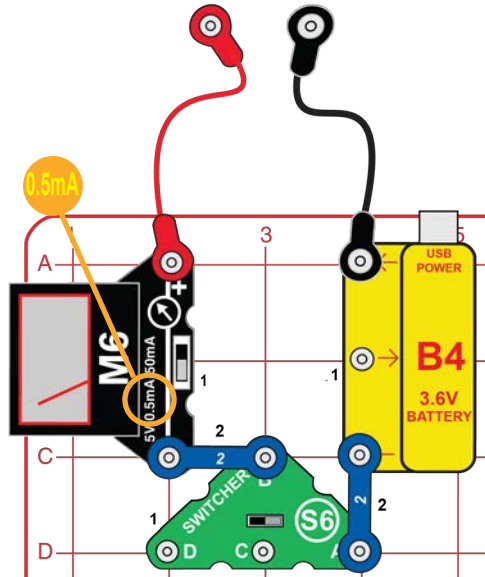

Build the circuit, set the meter (M6) to the 0.5mA setting & set the switcher (S6) to the right position.

Make your parts using either the water puddles method (A), the drawn parts method (B), or the pencil parts method (C). Touch the metal in the jumper wires to your parts and read the current.

See project 3 if you need to recharge the battery (B4).

Resistance = Voltage / Current, so you can use the battery voltage (3.6V) and the current you measure to find the resistance of your puddles and drawings.

Long narrow shapes have more resistance than short wide ones. The black core of pencils is graphite, the same material used in the resistors in the pivot stand.

Method A (easy): Spread some water on the table into puddles of different shapes, perhaps like the ones shown here. Touch the jumper wires to points at the ends of the puddles.

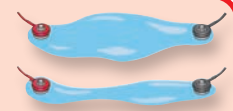

Method B (challenging): Use a SHARP pencil (No. 2 lead is best) and draw shapes, such as the ones here. Draw them on a hard, flat surface. Press hard and fill in several times until you have a thick, even layer of pencil lead. Touch the jumper wires to points at the ends of the drawings. You may get better electrical contact if you wet the metal with a few drops of water. Wash your hands when finished.



Method C (adult supervision and permission required): Change the setting on the meter to the 50mA scale. Use some double-sided pencils if available, or VERY CAREFULLY break a pencil in half. Touch the jumper wires to the black core of the pencil at both ends.



PROJECT 44 • Liquid Resistors

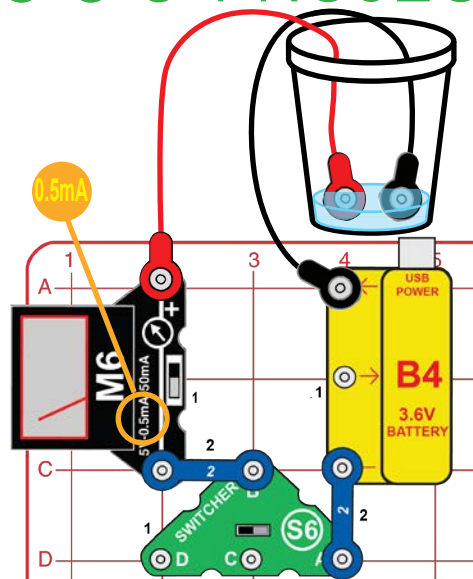

Build the circuit, set the meter (M6) to the 0.5mA setting, and set the switcher (S6) to the right position. Add about 1/4 inch of water to a cup or bowl. Connect the jumper wires to the circuit as shown and place the loose ends in the water, make sure the metal parts aren't touching each other. Measure the current through the water.

Add salt to the water and stir to dissolve it. The current should be higher now, since salt water has less resistance than plain water. If the current is too high to measure on the 0.5mA scale, switch to the 50mA scale.

Now add more water to the cup and watch the current.

If you have some distilled water, place the jumper wires in it and measure the current. You should measure close to zero current, since distilled (pure) water has very high resistance. Normal water has impurities, which lower its resistance. Now add salt to the distilled water and watch the current increase as the salt dissolves!

You can also measure the current through other liquids. **Don't drink any water or liquids used here.**

Pure water has very high resistance because its electrons are tightly held in place. Impurities (such as dissolved dirt, minerals, or salt) decrease the resistance because they have loose electrons, which disrupt the structure and make it easier for other electrons to move through.

PROJECT 45 Liquid Light

Replace the meter with the red/yellow LED (D10, positioned in either direction). Place the jumper wires back into water, into salt water, or on the shapes you drew.



PROJECT 46 • Moving Voltage

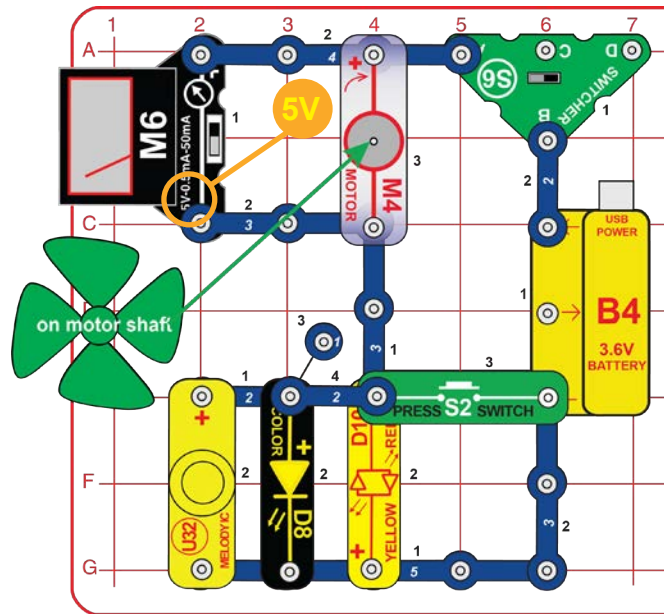

Build the circuit and set the meter (M6) to the 5V setting. Place the wind fan on the motor (M4). Set the switcher (S6) to the left position. The LEDs (D8 & D10) light, the melody IC (U32) makes sound, the fan spins, and the meter shows the voltage across the motor. You may need to give the fan a push to get it started. The voltage produced by the battery is split between the motor and the LEDs and melody IC.

Push the press switch (S2). The LEDs and melody IC turn off, the motor speeds up, and the meter shows a higher voltage across the motor. With the press switch on, the full voltage from the battery is available at the motor because the LEDs and melody IC are bypassed.

See project 3 if you need to recharge the battery (B4).

Switches are used to move voltage around a circuit.



PROJECT 47 • Moving More Voltage

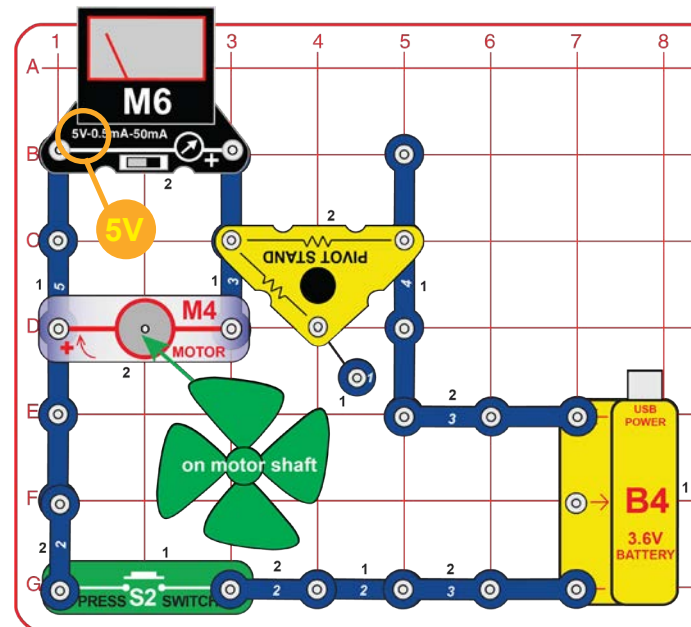

Part B

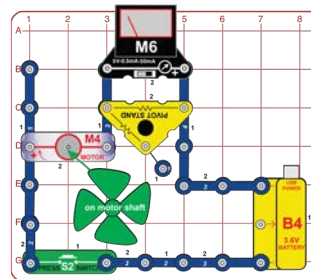

Build the circuit and set the meter (M6) to the 5V setting. Push the switch (S2); the meter measures the voltage across the motor. The voltage increases as the motor speeds up.

Part B: Move the meter so it is across the pivot stand. The pivot stand has a 47Ω resistor inside. Push the switch to measure the voltage across the pivot stand resistor.

Part C

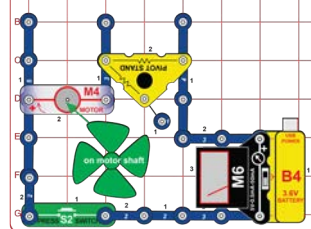

Part C: Move the meter so it is directly across the battery (B4). Push the switch to measure the voltage produced by the battery.

The motor voltage plus the picot stand voltage should about equal the battery voltage. It may be a little different, because the M6 meter has limited accuracy. The voltage across the switch will be very low when it is pressed.

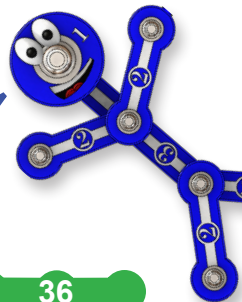

PROJECT 48 • Power Sources

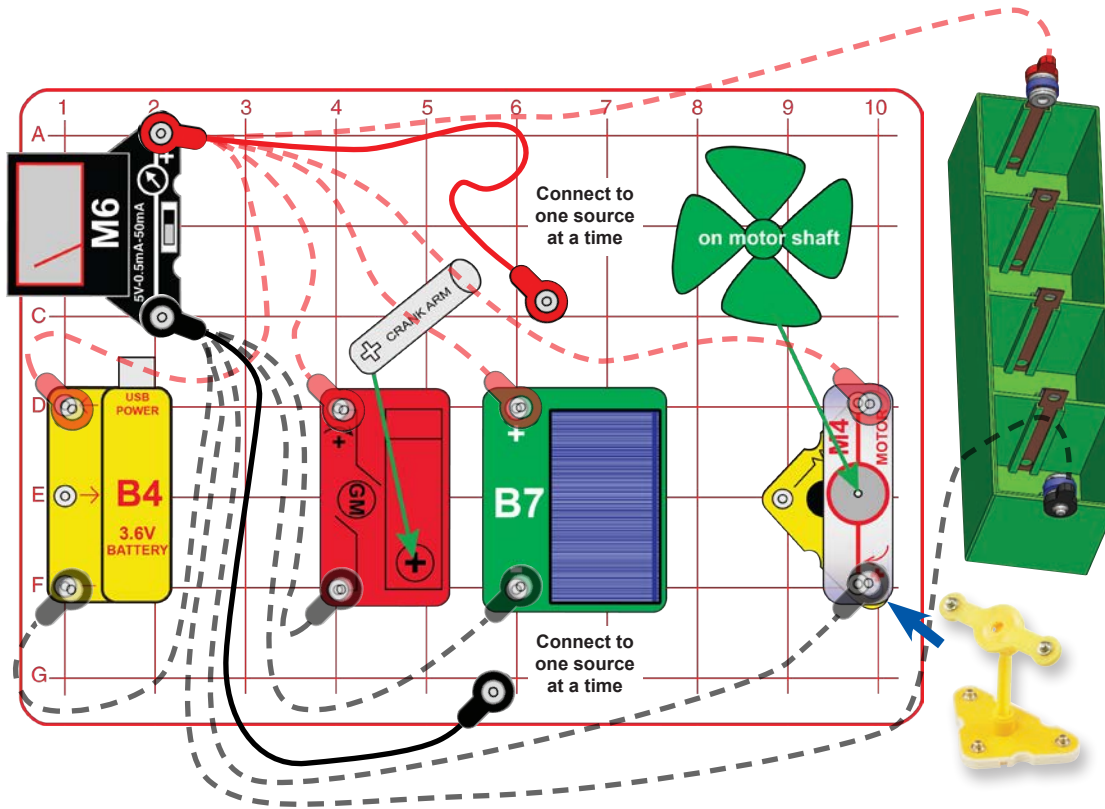

Snap Circuits® Green has 6 electrical power sources: battery, hand crank, solar cell, windmill, watermill, and liquid holder. Let's compare them. The watermill is similar to the windmill and its messy, so we'll skip it.

Connect the red & black jumper wires to the meter and to one of the power sources at a time, as shown. Measure the voltage produced using the 5V meter setting; then look at the current produced using either the 0.5mA or the 50mA meter settings. Some times the meter reading will be more than the 5V or 50mA scales. Take some notes in the table below.

- A. Battery.
- B. Hand Crank: Turn it clockwise at different speeds.
- C. Solar cell: Place it in sunlight or near an incandescent lamp.
- D. Windmill: Mount the motor on the pivot stand, place the wind fan on it, and blow on it or place it in a strong wind. You may need to give it a push to get it started.
- E. Liquid energy source: Assemble it using the instructions on page 4. Fill the compartments with cola or juice.

See project 3 if you need to recharge the battery (B4).

Power Source	Highest Meter Voltage	Highest Meter Current	Clock (Project 49)	Melody IC (Project 50)	LED (Project 51)	Big Voltage (Project 52)	Big Current (Project 53)
Battery							
Hand Crank							
Solar Cell							
Windmill							
Liquid							

The most powerful power source is the one which produces the best balance of voltage and current. Different types of circuits need different levels of voltage and current.

For each power source, the balance between voltage and current produced can be adjusted by changing its construction or with how groups of them are arranged.



PROJECT 49 Powering Clock

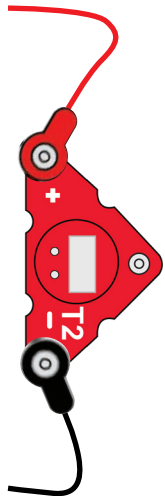

Use the 5 power sources you have set up in project 48 but replace the meter with the clock (T2) as shown. See if it works with each power source (it should). Take some notes in the project 48 table - it has a column for the clock.

You are not using the clock with a separate energy storage device, so notice how continuous power is from each source (for example, the clock stops when you stop turning the hand crank).

PROJECT 50 Powering Sound

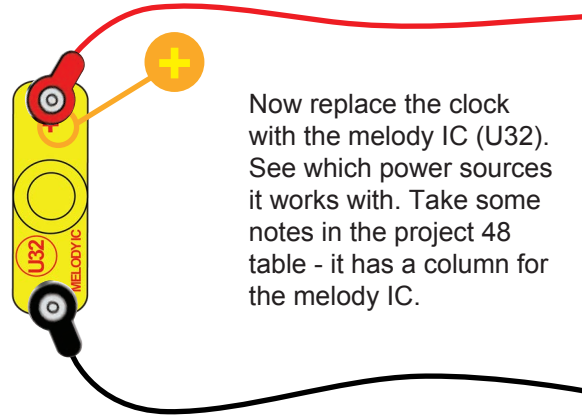

Now replace the clock with the melody IC (U32). See which power sources it works with. Take some notes in the project 48 table - it has a column for the melody IC.

PROJECT 51 Powering LED

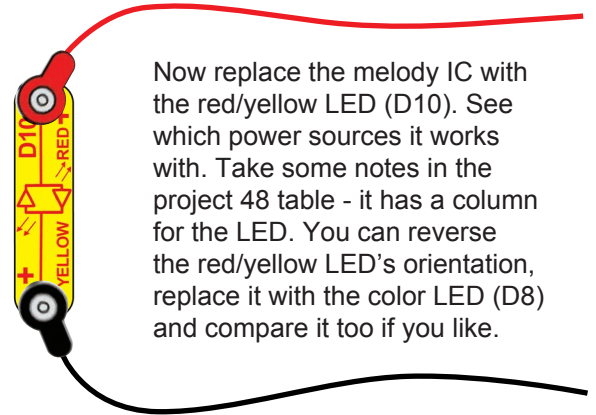

Now replace the melody IC with the red/yellow LED (D10). See which power sources it works with. Take some notes in the project 48 table - it has a column for the LED. You can reverse the red/yellow LED's orientation, replace it with the color LED (D8) and compare it too if you like.

PROJECT 52 Powering Big Voltage

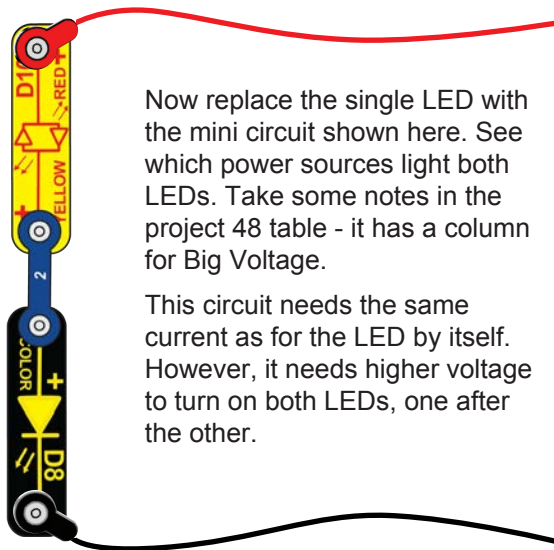

Now replace the single LED with the mini circuit shown here. See which power sources light both LEDs. Take some notes in the project 48 table - it has a column for Big Voltage.

This circuit needs the same current as for the LED by itself. However, it needs higher voltage to turn on both LEDs, one after the other.

PROJECT 53 Powering Big Current

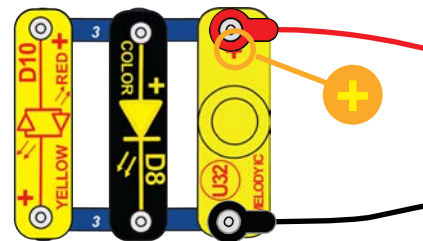

Now change to this mini circuit instead. Find out which power sources can run both LEDs and the melody IC. Take some notes in the project 48 table - it has a column for Big Current.

This circuit needs about the same voltage as for each device by itself, but it needs higher current to turn on all of them at the same time.

Each power source has advantages and limitations:

- A. Batteries have lots of power but they only store energy, they don't actually produce it.
- B. The hand crank has lots of power but only while you are turning the crank.
- C. The solar cell has limited power, and only while it has light.
- D. The windmill makes good power but only in a strong wind.
- E. The liquid energy source has very little power.



PROJECT 54 • Splitting Current

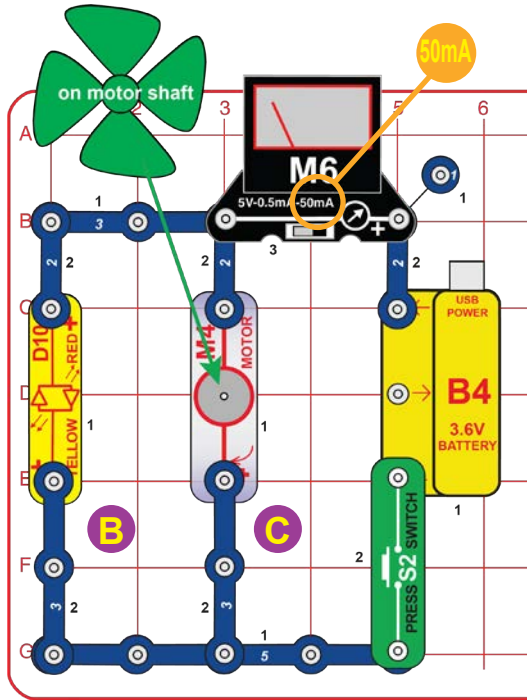

Part B

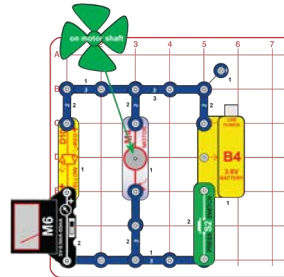

Build the circuit and set the meter (M6) to the 50mA setting. Push the switch (S2); the meter measures the current from the battery (B4). Let the fan get to full speed.

Part B: swap the location of the meter with the 3-snap wire marked “B” (“+” side towards the red/yellow LED (D10)). Push the switch to measure the current through the LED (D10).

Part C: swap the “B” location of the meter with the “C” 3-snap. Push the switch to measure the current through the motor (M4).

See project 3 if you need to recharge the battery (B4).

Part C

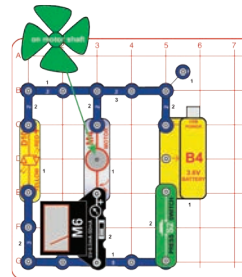

The current from the battery splits up between the LED and the motor. If you add up the current you measured through the LED and motor (Parts B & C), it should be the same as the current you measured from the battery. (Your result may be a little different, because M6 is a simple meter with low accuracy.)

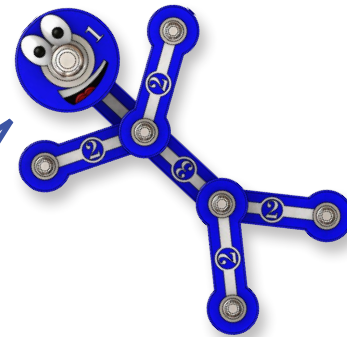

PROJECT 55 • Splitting Current Differently



Replace the red/yellow LED or motor with the color LED (D8, “+” on top) or melody IC (U32, “+” on top). Try different combinations and see how the current changes.

PROJECT 56 • Wind Direction

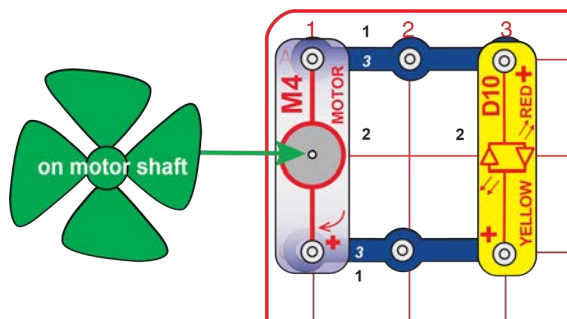

Blow on the fan or spin it with your fingers. The rotating shaft on the motor (M4) generates a current and the LED (D10) lights.

Spin the fan in the other direction (or reverse the position of the motor and blow on it), so it generates a current in the opposite direction. The LED (which is bi-color) now lights in a different color than before.

As the fan spins faster, the LED lights brighter. You can use this circuit as a wind direction and speed indicator.

PROJECT 57 • Voltage Order

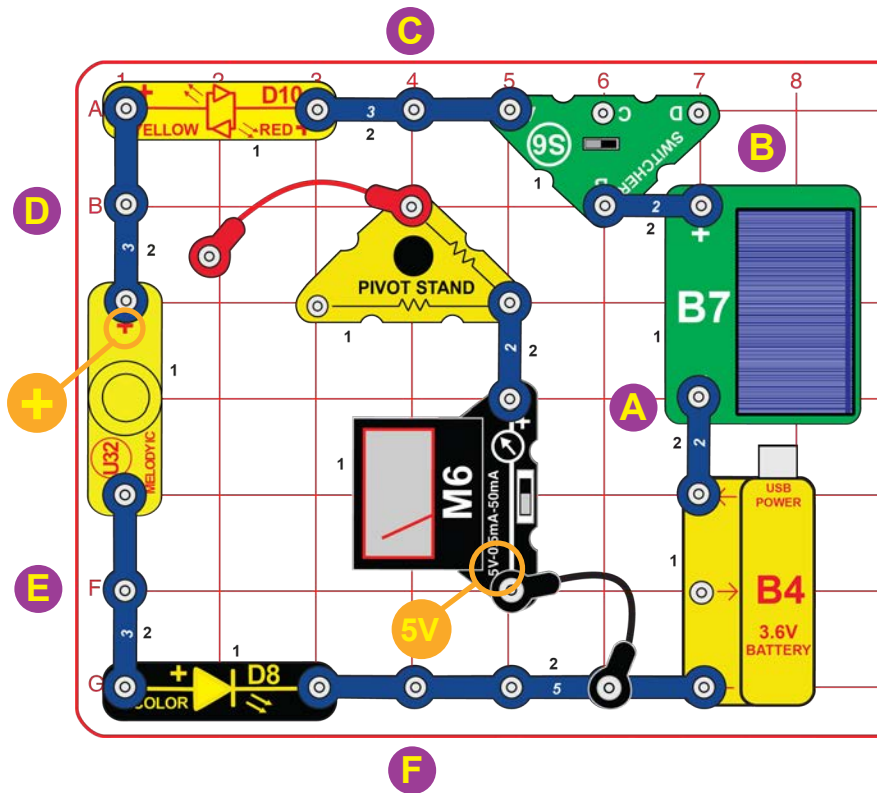

Build the circuit and set the meter (M6) to the 5V setting. Connect the black jumper wire between the meter and 5-snap wire. Connect one end of the red jumper wire to the pivot stand; leave the other end loose. Set the switch (S6) to the left position. Place the solar cell (B7) in bright sunlight or near an incandescent lamp. If the light is bright enough, the LEDs (D8 & D10) will light and the melody IC will make a little noise.

See project 3 if you need to recharge the battery (B4).

- This circuit has the battery (B4) and solar cell producing voltage to push electric current through the LEDs and melody IC. Although the meter is set to the 5V scale, a resistor in the pivot stand changes the voltage scale to 10V, so double the voltage you read on the meter.
- A. Connect the loose end of the red jumper wire to the snap marked A to measure the voltage between there and the black jumper wire's location. It is just the voltage across the battery.
 - B. Move the end of the red jumper from point A to point B, to see how much the voltage is increased by the solar cell.
 - C. Move the end of the red jumper from point B to point C, to see how much the voltage changed across the switch.
 - D. Move the end of the red jumper from point C to point D, to see how much the voltage was reduced as it pushed current through the red/yellow LED.
 - E. Move the end of the red jumper from point D to point E, to see how much the voltage was reduced as it pushed current through the melody IC.
 - F. Finally, move the end of the red jumper from point E to point F, to see how much the voltage was reduced as it pushed current through the color LED.
- Part 2: Take the end of the black jumper wire off the 5-snap wire. Place the loose ends of the red and black jumper wires across any two points in the circuit to measure the voltage change between them (remember that the meter only measures positive voltages).

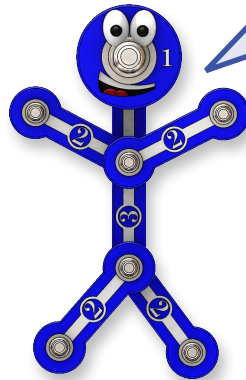

PROJECT 58 • Current Order

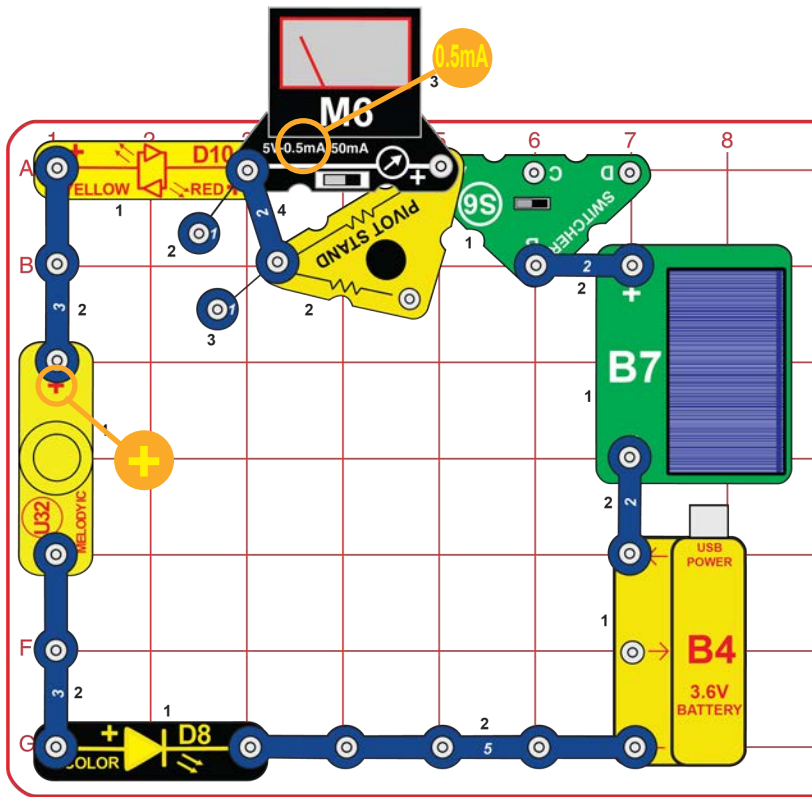

Build the circuit; it has the parts arranged in a loop. Set the meter (M6) to the 0.5mA setting. Set the switcher (S6) to the left position. Place the solar cell (B7) in bright sunlight or near an incandescent lamp. If the light is bright enough, the meter will show a current, the LEDs (D8 & D10) will light, and the melody IC (U32) will make a little noise.

Note: The 0.5mA meter scale is actually a 5mA scale due to a resistor in the pivot stand being used to scale the current. When re-arranging the parts in Part B, treat the “5mA meter group” as a single module.

Part B: Rearrange the parts around the loop into the order shown, or any similar order you like. Keep the “+” side of the parts in the same direction as you move parts around the loop, and keep the light on the solar cell the same as before. The LED brightness, melody IC sound, and current shown on the meter should be the same no matter how you order the parts.

See project 3 if you need to recharge the battery (B4).

This circuit has the battery (B4) and solar cell producing voltage to push electric current through the LEDs and melody IC. The current is flowing counter-clockwise around the loop, and is the same through all parts. If you rearrange the parts in the loop, without changing their “+” orientation to the flow of current, then you have exactly the same circuit.

5mA meter group

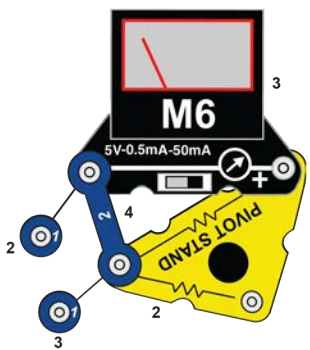

Part B

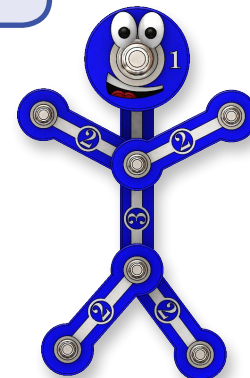
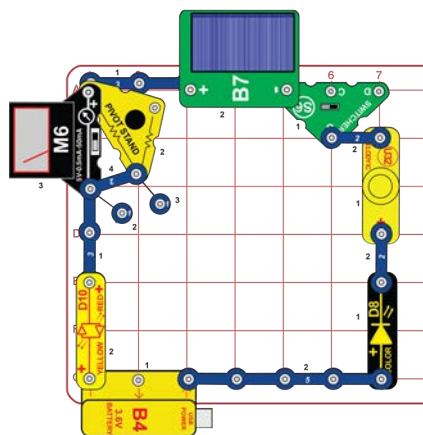

PROJECT 59 • Sources in Series

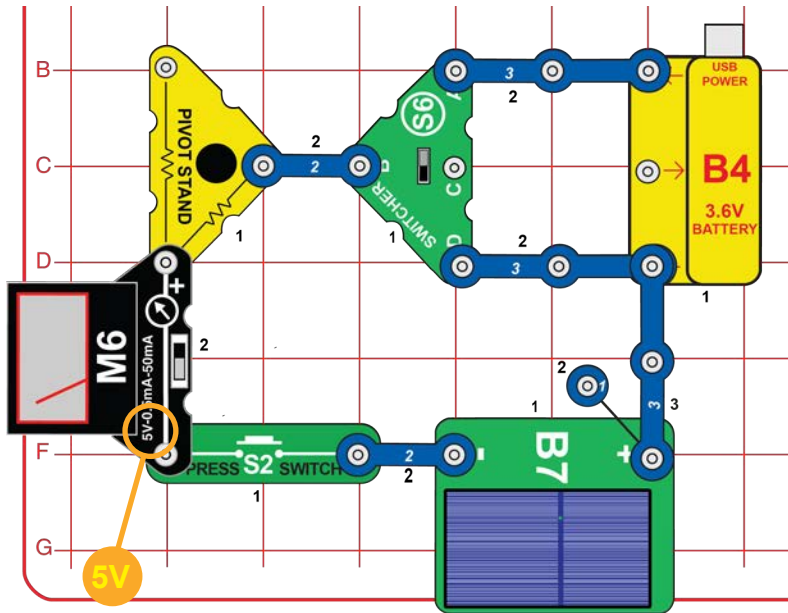

Build the circuit shown. Place the solar cell (B7) in sunlight or close to an incandescent lamp. Set the meter to the 5V setting, but double the reading it shows, since a resistor in the pivot stand converts the scale to 10V. Push the press switch (S2). If the switcher (S6) is set to the upper position, then the meter shows the combined battery (B4) and solar cell (B7) voltage. If it is set to the lower position, then the meter shows only the solar cell voltage.

Vary the light on the solar cell and see how the voltage changes.

See project 3 if you need to recharge the battery (B4).

The voltage produced will be lower when these sources are running something that needs lots of current, because the solar cell can only produce a small amount of current.



PROJECT 60 • Sources in Parallel

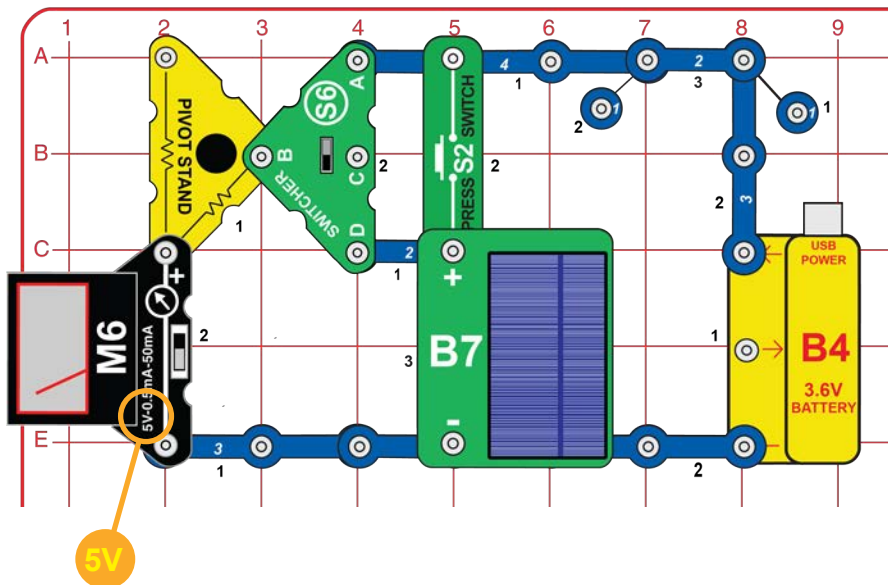

Build the circuit shown. Place the solar cell (B7) in sunlight or close to an incandescent lamp. Set the meter to the 5V setting, but double the reading it shows, since a resistor in the pivot stand converts the scale to 10V. If the switcher (S6) is set to the upper position, then the meter shows the battery (B4) voltage. If it is set to the lower position, then the meter shows the solar cell (B7) voltage.

If you push the press switch (S2), then the battery and solar cell are connected in parallel with each other, and the meter shows the resulting voltage. Vary the light on the solar cell and see how the total voltage changes.

PROJECT 61 • Two in Series

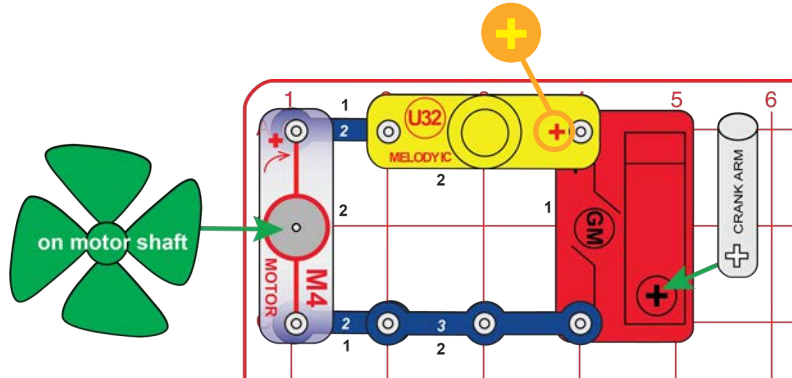

Turn the crank arm clockwise to run the fan and melody IC (U32).

Current flows from the geared motor (GM), through the melody IC, then through the motor/fan, and then back to the geared motor. If you remove the melody IC or motor (M4) from the circuit then the other will not work, because they are connected in series.

Connecting components in series makes wiring easier, and allows one to control others (like having a switch control a lamp in your home).



PROJECT 62 • Two in Parallel

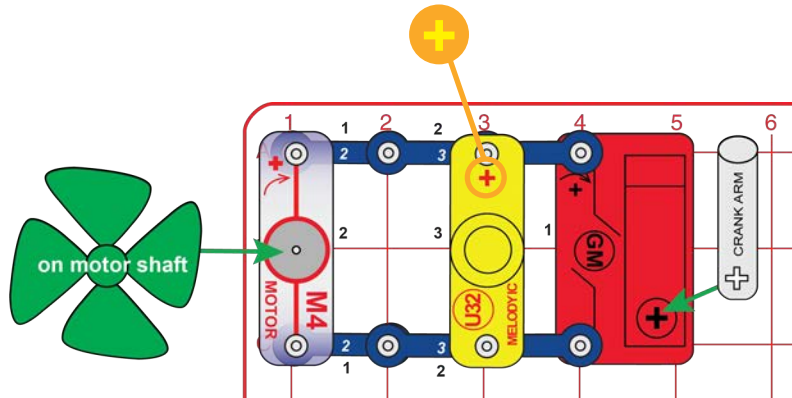

Turn the crank arm clockwise to run the fan and melody IC (U32).

Compare how hard it is to turn the crank arm in this circuit and the preceding one.

Current flows from the geared motor (GM), then splits up so some goes through the melody IC and some goes through the motor/fan, and then it all comes back to the geared motor. If you remove the melody IC or motor (M4) from the circuit then the other will still work, because they are connected in parallel.

Notice that the crank arm is harder to turn in this circuit (with U32 and M4 in parallel) than in the preceding one (where U32 and M4 were in series). This is because more power is used by components connected in parallel.

The lights in your home are wired in parallel so if one burns out, the others stay on.

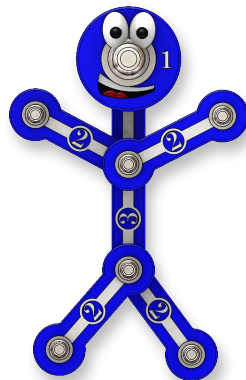

PROJECT 63 • Two LEDs Series

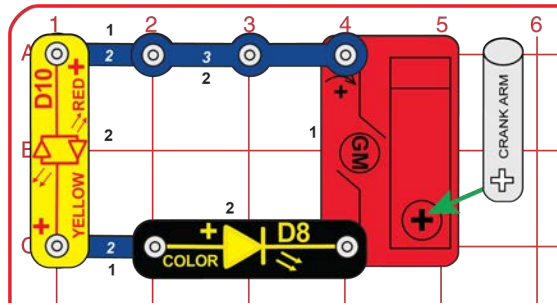

Turn the crank arm clockwise to light the LEDs (D8 & D10). Turn the crank at a constant speed so both LEDs light, and notice how both are flashing.

The color LED briefly turns off as it changes colors, causing the red/yellow LED to flash at the same time, because both LEDs are connected in series.



PROJECT 64 • Two LEDs in Series-Filtered

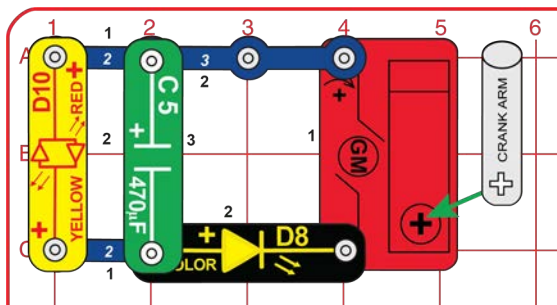

Turn the crank arm clockwise to light the LEDs (D8 & D10). Turn the crank at a constant speed so both LEDs light, and notice how now the red/yellow LED brightness does not vary as much.

The 470mF capacitor (C5) filters out most of the voltage disturbance that occurs when the color LED changes colors, so the brightness of the red/yellow LED is not affected as much as in the preceding circuit.



PROJECT 65 • Two LEDs in Parallel

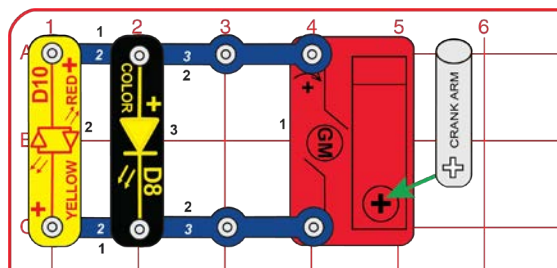

Turn the crank arm clockwise to light the LEDs (D8 & D10). Turn the crank at a constant speed so both LEDs light, and notice how only the color LED is flashing now.

In this circuit the red/yellow LED is not flashing. The color-changing of the color LED does not affect the red/yellow LED because they are connected in parallel, so they do not affect each other.



PROJECT 66 • Wind Sound

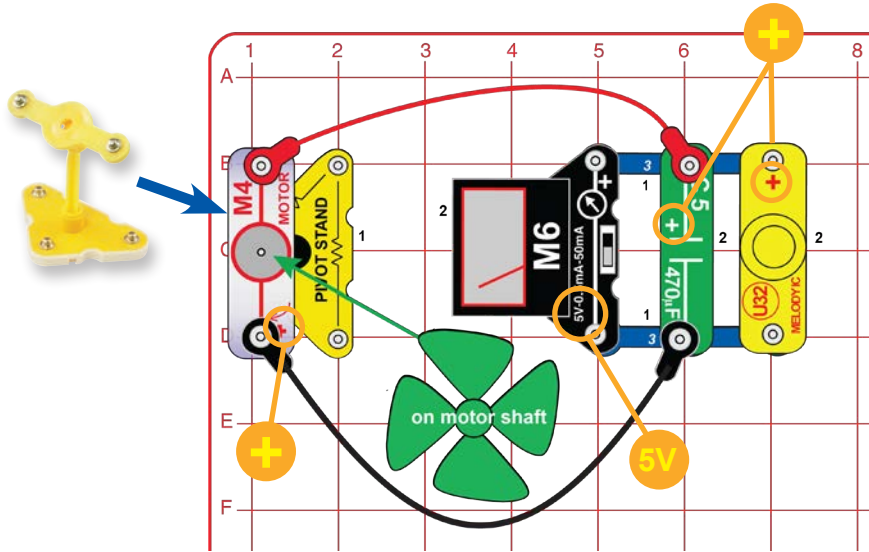

Build the circuit shown. Set the meter (M6) to the 5V setting. Blow on the fan or place it in a strong wind (either outside or near an electric fan). The meter measures how much voltage your “windmill” produces, and the melody IC (U32) makes sound from the voltage. The sound will be brief and not very loud.

The electricity produced by the windmill motor is constantly changing, due to the mechanical design of the motor and variations in wind speed. The horn needs a steady voltage to work properly, so the 470mF capacitor (C5) is used. The capacitor stores a small amount of electricity and then releases it as needed to steady the voltage.

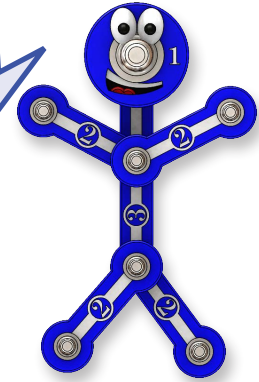

PROJECT 67 • Windy Time

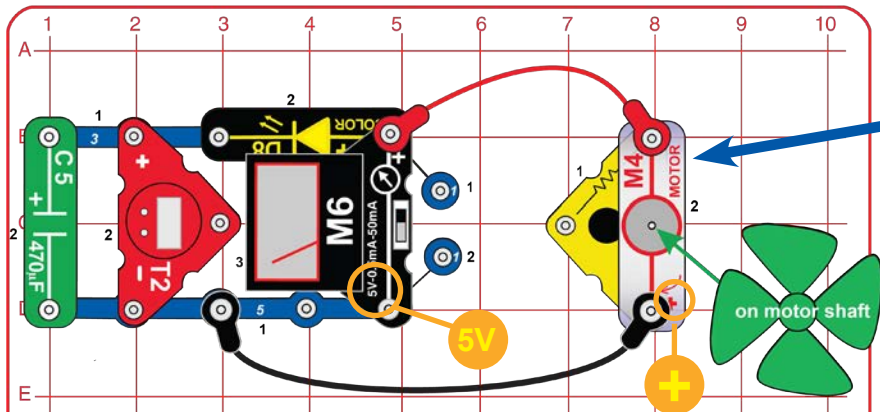

Build the circuit shown. Set the meter to the 5V setting. Blow on the fan or place it in a strong wind (either outside or near an electric fan). The meter (M6) measures how much voltage your “windmill” produces. You may need to give the fan a push to get it started.

The clock display (T2) should be on, and stay on for a while when the wind is not blowing. Together the “windmill” and capacitor (C5) can run the clock using free, clean wind power. The color LED (D8) will not light.

If you would like to set the time on the clock, see page 4.

The 470mF capacitor (C5) can store a small amount of electricity. The clock needs very little electricity to operate, so the capacitor can run it for a while when the wind is not blowing.

The color LED is like a one-way light, only allowing electricity to flow in one direction. Here it is used to prevent electricity stored in the capacitor from discharging through the motor when the wind is not blowing.



PROJECT 68 • Wind Charger with Light

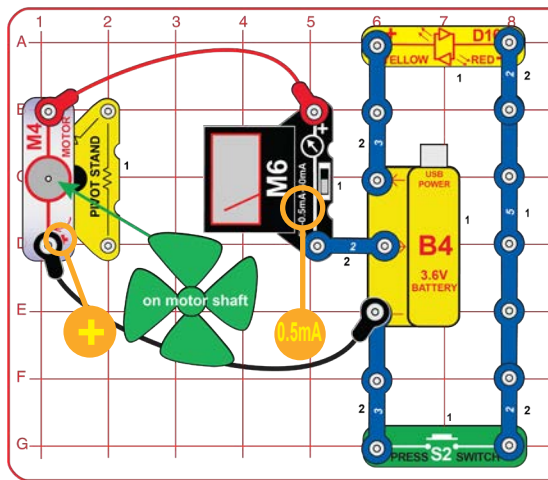

Build the circuit shown. Set the meter (M6) to the 0.5mA setting. Blow hard on the fan or place it in a very strong wind (either outside or near an electric fan). The “windmill” charges the battery (B4) when the wind is blowing hard, and the meter measures the charging current. Push the press switch (S2) to turn on the LED (D10).

A problem with using wind to power a light is that the wind isn’t always blowing when you need the light on. On the other hand, the wind is often blowing when you don’t need the light on. So here you use the battery to store energy from the windmill when the wind is blowing, and then run the LED when you need the light on. This way light is always available from clean, free wind power.



PROJECT 69 • Wind Charger with Sound

Replace the red/yellow LED (D10) with the melody IC (U32, “+” on left). The circuit works the same except pressing the switch makes sound. Here the melody IC is run using wind power, by using the battery for storage.

Ice Storage units utilize a conventional air conditioner to make ice at off hours using off-peak electricity that is often sold at lower rates. The ice is stored in a large, well-insulated tank. When there is demand for air conditioning, refrigerant is circulated through coils in the ice. The chilled refrigerant then flows through the building’s air-conditioning system inside the home or business to provide cooling.



PROJECT 70 • Kick Start Motor

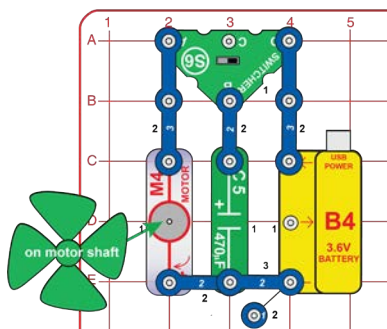

Sometimes motors under a load are difficult to get started. A capacitor can be used to give the motor a little kick. In this project setting the switcher (S6) to the right will charge the 470mF capacitor (C5), then moving it to the left will give the motor a little kick. Since no other power is applied, the motor will not go very far on the small amount of power stored in the capacitor. This is still a good way to get a motor started as power is supplied.

When this technique is used, they call the capacitor a “Starting Capacitor”. A capacitor start motor is a split-phase induction motor with a starting capacitor inserted in series with the startup winding, creating a much greater starting torque.

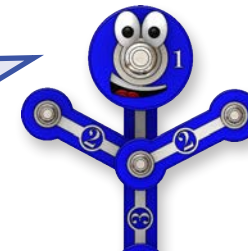

PROJECT 71 • Liquid Battery

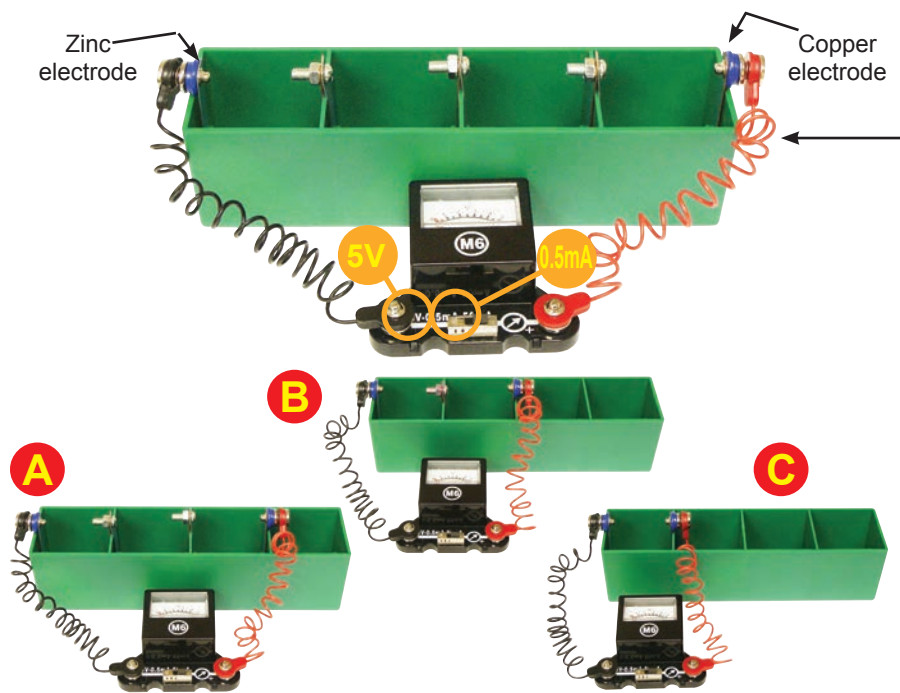

Assemble the liquid energy source using the instructions on page 4. Connect the red & black jumper wires between the meter (M6) and the electrodes, the (+) side of the meter goes to the copper one. Set the meter to the 5V setting. Fill the compartments with cola soda (other flavors also work). The meter should show a voltage of about 3V. Switch the meter to the 0.5mA setting to measure the current produced.

Move the copper electrode with the snap on it over to the next compartment, as shown (“A”). Use the 5V setting to measure the voltage and the 0.5mA setting to measure the current. The voltage should only be about 3/4 of what it was, since you have one less compartment. The current should be about the same.

Now move the copper electrode with snap to the next compartment, so only two are used (“B”) See how the voltage drops even more, but the current changes little.

Now move the copper electrode with snap to the same compartment as the electrode with snap, so you only have one cola “cell” (“C”). Measure the voltage and current now.

Don't drink any soda or juice used in this project. Wash the electrodes and liquid holder.

Note: Your actual results may vary. Your M6 meter is a simple meter; don't expect it to be as accurate as normal electronic test instruments.

Cola-flavored soda is lightly acidic. The acid is similar to the material used in some types of batteries but not as strong. The acid in the cola reacts with the copper and zinc electrodes to make an electric current, just like a battery. As some of the acid in the soda is used up, the current produced drops.

Each of the compartments in the liquid energy source produces about 0.75V, though the current is low. When the four compartments are connected in a series, their voltages add together to make about 3V total, but the current is the same. Each compartment is like a cell of a battery. Your B4 rechargeable battery actually contains three 1.2V “cells” in a series, just like the “cells” of the liquid energy source.

Soda can be used in this way to produce electricity, but it does not produce very much, so is not widely used. However, biomass power plants, which burn decaying food products and yard waste, are increasingly being used. These plants produce electricity from garbage that would otherwise be filling up landfills, and they don't pollute the environment.

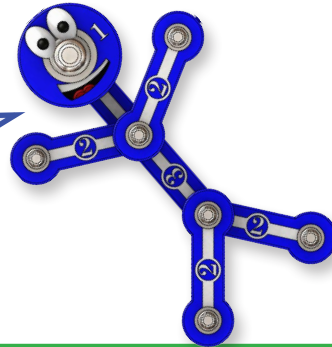

PROJECT 72 • Juice Battery

Replace the soda in the liquid energy source with fruit juice. Sour tasting juices like lemon or grapefruit work best. Measure the voltage and current for your juice battery like you did with the soda. Try different juices and compare them. Don't drink any soda or juice used in this project. Wash the electrodes and liquid holder.

Some fruits and vegetables have a sour taste because they are lightly acidic. This acid can be used to produce electricity just like the cola and batteries do.

Using the natural chemical energy in fruit is a very green (environmentally friendly) way to produce electricity.



PROJECT 73 • Cola Light

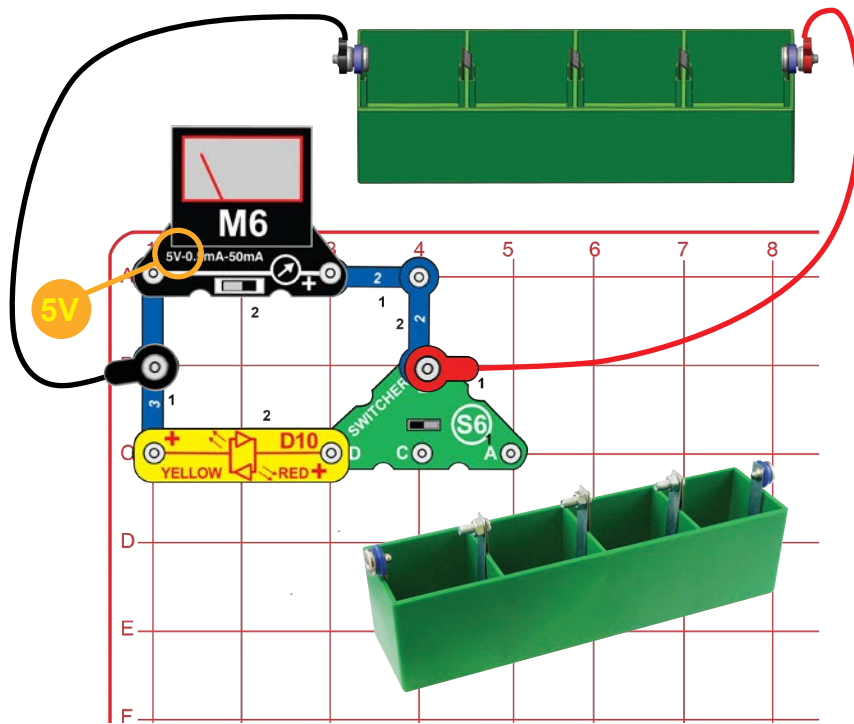

Assemble the liquid energy source using the instructions on page 4. Build the circuit and connect the red & black jumper wires; the red wire goes to the copper electrode. Set the meter (M6) to the 5V setting. Fill the compartments with cola soda (other soda flavors and lemon, tomato, or grapefruit juice also work). Set the switcher (S6) to the right position. The meter shows the voltage produced.

Now set the slide switch to the left position to connect the red/yellow LED (D10). The LED should be on, though it may be dim. The voltage shown on the meter may be lower now, because the cola may not be able to make as much electricity as the LED wants. If you watch the circuit for a while, the LED brightness and voltage may slowly drop as the cola reacts with the electrodes to produce electricity.

Remove the meter from the circuit. The LED may be brighter, because all the electricity produced is going to the LED now.

You can move the copper electrode with the snap on it over to the next compartment, as shown in the Liquid Battery project. The LED will be dimmer or not light at all, because the voltage is lower.

If the copper and zinc electrodes get corroded through use, use sandpaper, steel wool, or a scraper to remove the corrosion and improve performance.

Don't drink any soda or juice used in this project. Wash the electrodes and liquid holder.

When used to measure voltage (5V setting), your M6 has a high resistance of about 10KW, which is placed in parallel with the voltage you are measuring. A very small amount of current will be diverted into the meter, but this will usually not have any effect on the circuit. However sometimes, if your voltage source can only produce a small amount of current, it changes the circuit operation. That is why the LED can get brighter when you remove the meter from this circuit.

When used to measure current, your M6 meter has a resistance of about 500W in the 0.5mA setting and about 10W in the 50mA setting, which is placed in the circuit so the current flows through it. This meter resistance will reduce the current it is trying to measure, but the effect will be small if the meter is set to the appropriate current scale.

Your M6 meter is a simple meter. Normal electronic test instruments can make better measurements, because they have less effect on the circuits they are measuring, but even they have limitations and they can be very expensive.

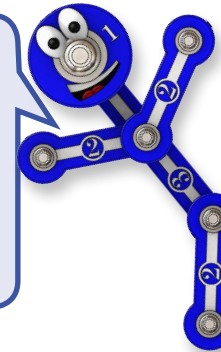

PROJECT 74 • Yellow Cola

Replace the red/yellow LED (D10) with the color LED (D8). Compare the LED brightness and voltage change to the red/yellow LED in the preceding project.

The liquid energy source does not produce enough electricity to run the melody IC (U32) or motor (M4).

It takes higher voltage to turn on the green and blue light effects than red, so those colors will be dimmer.

If you had pipes pumping fresh cola into the liquid cells and removing some of the used liquid, then the LED would stay lit as long as the flow was maintained - it would be a fuel cell.



PROJECT 75 • Electricity From Water

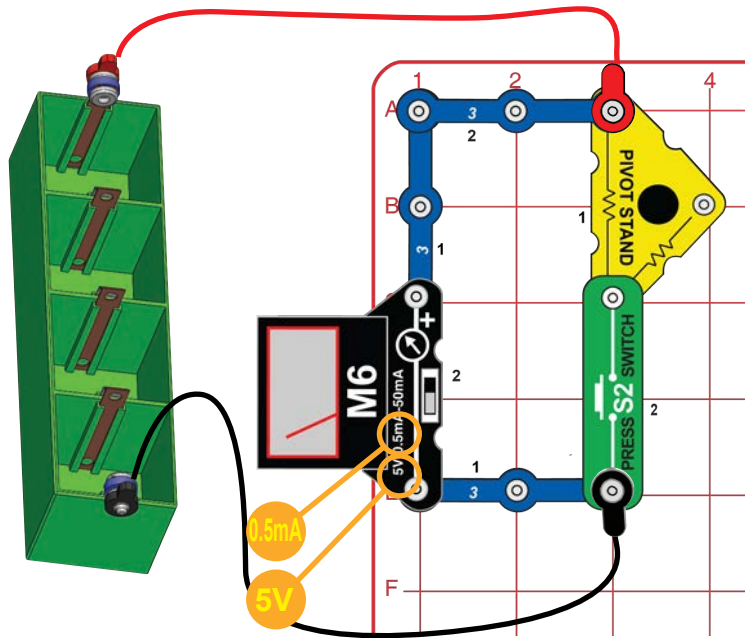

Assemble the liquid energy source using the instructions on page 4. Build the circuit and connect the red & black jumper wires; the red wire goes to the copper electrode. Set the meter (M6) to the 5V setting. Fill the compartments with water. The meter shows the voltage produced, if any.

Set the meter to the 0.5mA setting to see how much current your water can supply, if any. If the reading is higher than 0.5mA, push the press switch to change the current scale to 5mA. (The switch adds a 47Ω resistor in the pivot stand to the circuit, changing the current scale on the meter. It should not be used with the 5V setting.)

Try dissolving some salt in the water in all four compartments. The voltage and current should be higher now. If you have some distilled water, test it too (rinse out the salt water first). The voltage and current produced should be zero now.

Don't drink any water used in this project. Wash the electrodes and liquid holder.

The water in some areas is slightly acidic due to impurities in it. This may be strong enough to produce electricity by reacting with the electrodes, similar to how a battery works. These impurities should be safe to drink. Distilled water has almost no impurities.



PROJECT 76 • Water Light

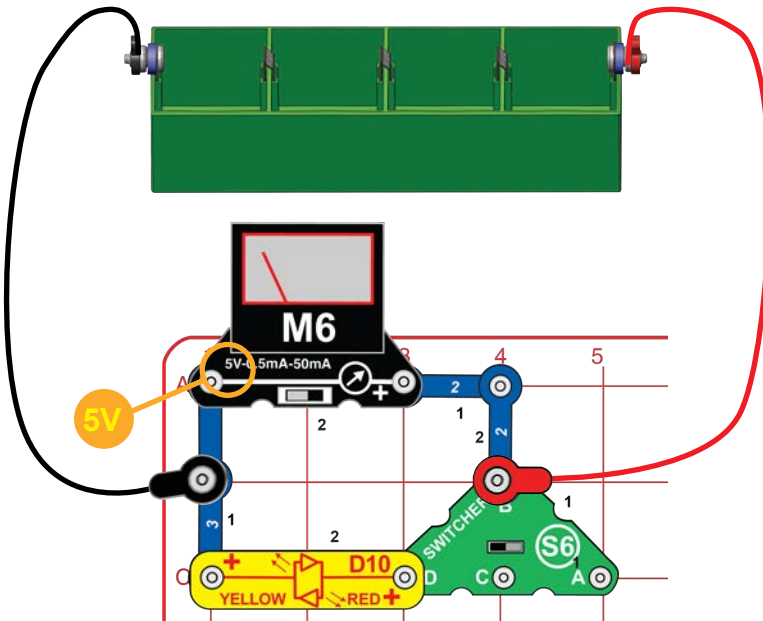

Connect the liquid energy source to the circuit shown here. Fill the compartments with water. Set the switcher (S6) to the left position. Set the meter (M6) to the 5V setting to see the voltage produced. The red/yellow LED (D10) may be dimly lit, depending on your local water supply. If you set the switcher to the right position, the voltage may be higher since the water is not trying to light the LED.

Dissolve some salt in the water in all four compartments. The voltage will be higher and the LED should light now. See how long it lights the LED for.

Try replacing the red/yellow LED with the color LED (D8) or the clock (T2). See how long the water can run the clock. If you would like to set the time, see page 4.

Salt and other impurities in the water react with the electrodes to produce electricity like the cola does in project 73. The voltage produced by the water is usually lower and water will not run the LED or clock as long.



PROJECT 77 • Cola Clock

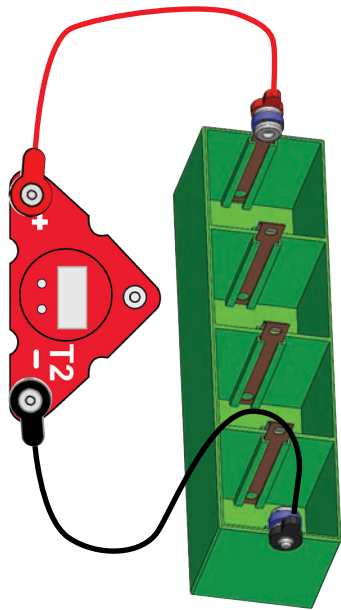

Setting the time on the clock (T2):

- Press the left button to select what to change (month, date, hour, or minutes).
- Press the right button until it is correct.
- Press the left button until the time is showing, then press the right button once to start.
- The colon (":") will be flashing when the clock is running.
- Press the right button to display the date.

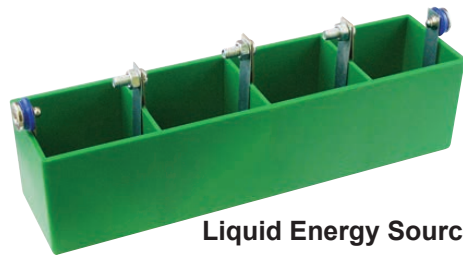

Liquid Energy Source

Assemble the liquid energy source using the instructions on page 4. Connect it to the clock (T2) with the red & black jumper wires, the red wire goes to the copper electrode. Fill the compartments with cola soda (other soda flavors and lemon, tomato, or grapefruit juice also work). The clock should be running. Set the time if you like.

With cola, the clock will typically run for a week. When the display gets dim, replace the cola.

You can move the copper electrode with the snap on it over to the next compartment, as shown in the Liquid Battery project. The clock display will not be as bright now.

If the copper and zinc electrodes get corroded through use, use sandpaper, steel wool, or a scraper to remove the corrosion and improve performance.

Don't drink any soda or juice used in this project. Wash the electrodes and liquid holder.

The clock needs very little electric current to operate (much less than 1mA). The liquid power source does not produce much electricity, but it can supply enough for the clock. Slowly, the chemical energy in the cola is used up, and the voltage drops enough for the clock to stop working.



PROJECT 78 • Cola Clock with Memory

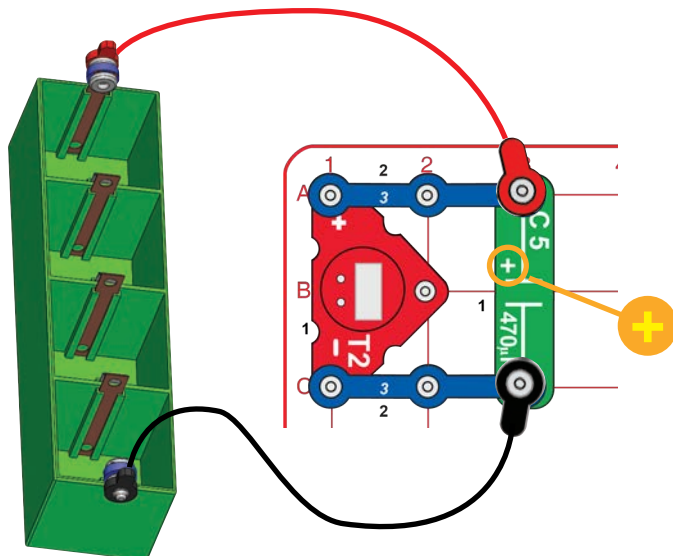

In the preceding Cola Clock project, when you disconnect the liquid energy source to replace the cola, the time is lost. Wouldn't it be nice if the clock remembered the time long enough for you to replace the cola?

Add the 470mF capacitor to the clock as shown here. The capacitor stores enough electricity to run the clock for a while if you disconnect the liquid energy source.

Don't drink any soda or juice used in this project. Wash the electrodes and liquid holder.

You could also use a battery for electricity storage instead of the capacitor. A battery stores much more electricity than a capacitor but you don't need much storage here. Batteries are much more expensive than capacitors and contain chemicals that can harm the environment when you throw them away.



PROJECT 79 • Changing Water Pressure to Electrical Pressure

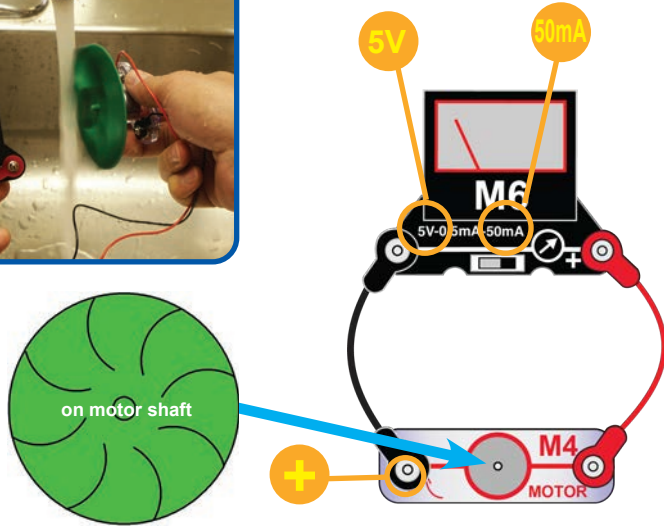

Place the water wheel on the motor (M4) and connect it to the meter (M6), as shown. Set the meter to the 5V or 50mA setting. Hold the motor under a water faucet so the water wheel will “catch” the water as it falls. See how much voltage and current you can produce.

Using the water pressure from your faucet to make electricity using the motor (used as a generator here) is just like using water pressure from a lake to run an electric generator in a dam.

Your parts might stop working if water gets inside them. Let them dry out and they should be fine.

Hoover Dam has a lake that is 500 feet deep on one side to provide great pressure to turn the generators that make our electricity.

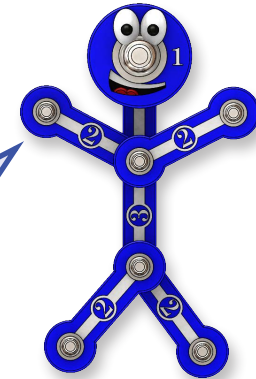

PROJECT 80 • Storing Energy in Water

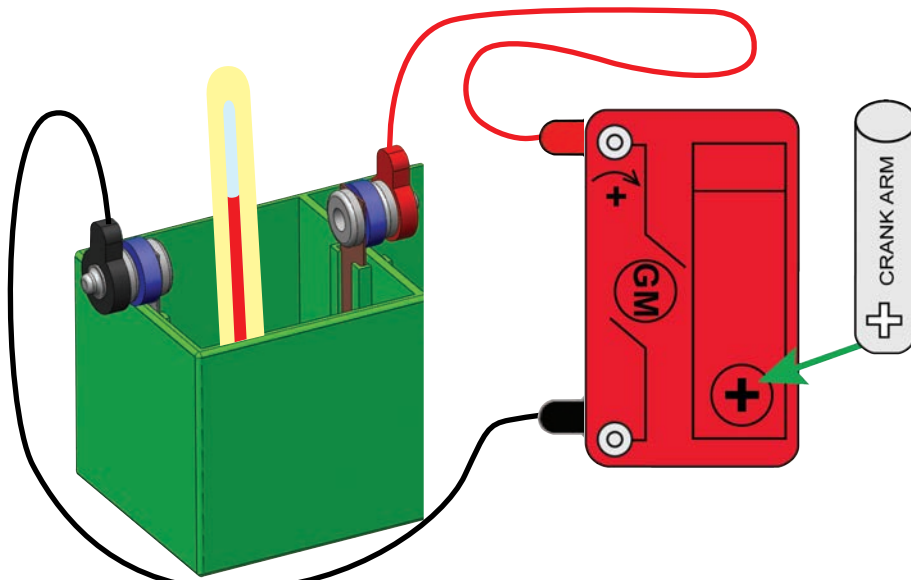

Place ½ teaspoon of salt into a small amount of water and stir until it dissolves. You can use a compartment on the liquid power source for this, but don't use a metal container. If available, use a thermometer from your home to measure the water temperature. If no thermometer is available, test the water temperature by touching it with your finger. Connect the red & black jumper wires to the geared motor (GM) and place the loose ends in the water so they aren't touching. Place the crank arm on the geared motor

Turn the crank to heat the water. You should see the temperature rise on the thermometer or feel the difference with your finger. You may have to crank for a minute or two before the water gets warmer.

Solar or wind power may be used to heat water during the day, then use the hot water to keep homes warm at night.



PROJECT 81 • Hydro Lights

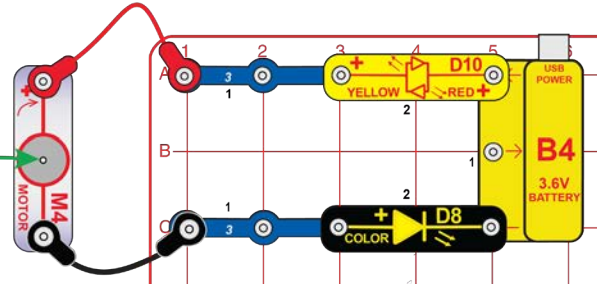

Place the water wheel on the motor (M4) and connect it to the circuit as shown. Hold the motor under a water faucet so the water wheel will “catch” the water as it falls. The LEDs (D8 & D10) should light.

Your parts might stop working if water gets inside them. Let them dry out and they should be fine.

PROJECT 82 • Directional Wind Lights

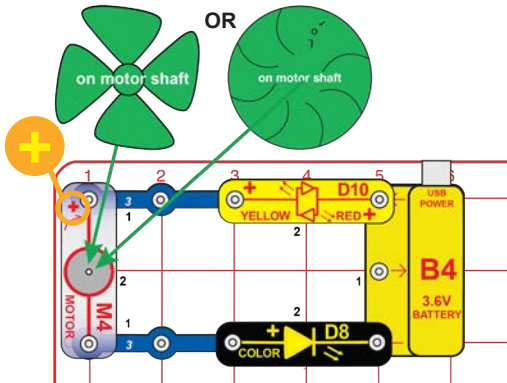

Build the circuit, and place either the wind fan or the water wheel on the motor (M4). To make the LEDs (D8 & D10) bright, blow on the wind fan from above, or blow into the “curves” of the water wheel.

See project 3 if you need to recharge the battery (B4).

PROJECT 83 • Emergency Transmission Loss

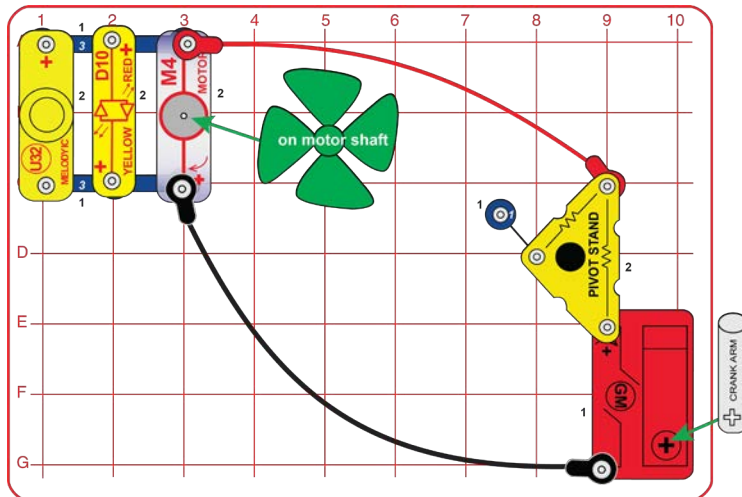

Turn the crank arm on the geared motor (GM) clockwise to run the motor (M4) and fan, red/yellow LED (D10), and melody IC (U32) or turn it backwards to run just the motor and LED.

If you remove the pivot stand base and connect the red jumper wire directly to the geared motor then there will be a little more light, sound, and motion.

Think of this circuit as an electricity distribution system, like the one powering your home. The geared motor and crank represent a big electric generator driven by steam or water pressure at an electric power plant. The red & black jumper wires represent the power lines distributing electricity from the power plant to homes. A resistor in the pivot stand base represents the electricity lost in distributing electricity across long distances. The fan, LED, and melody IC represent appliances, lights, and music devices using electricity in homes.



PROJECT 84 • Using Stored Water

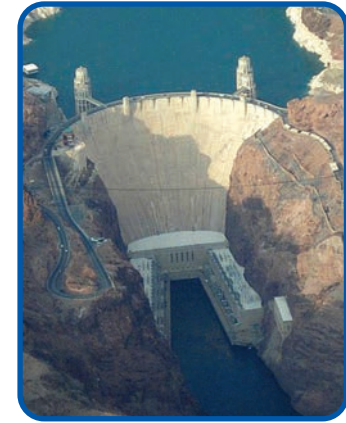
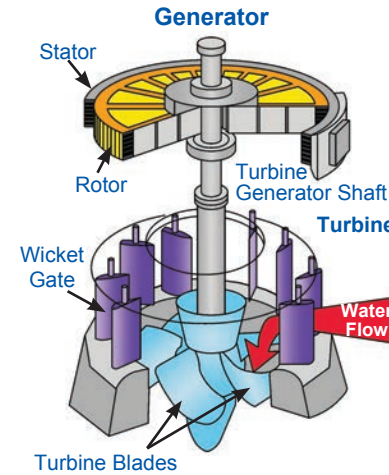
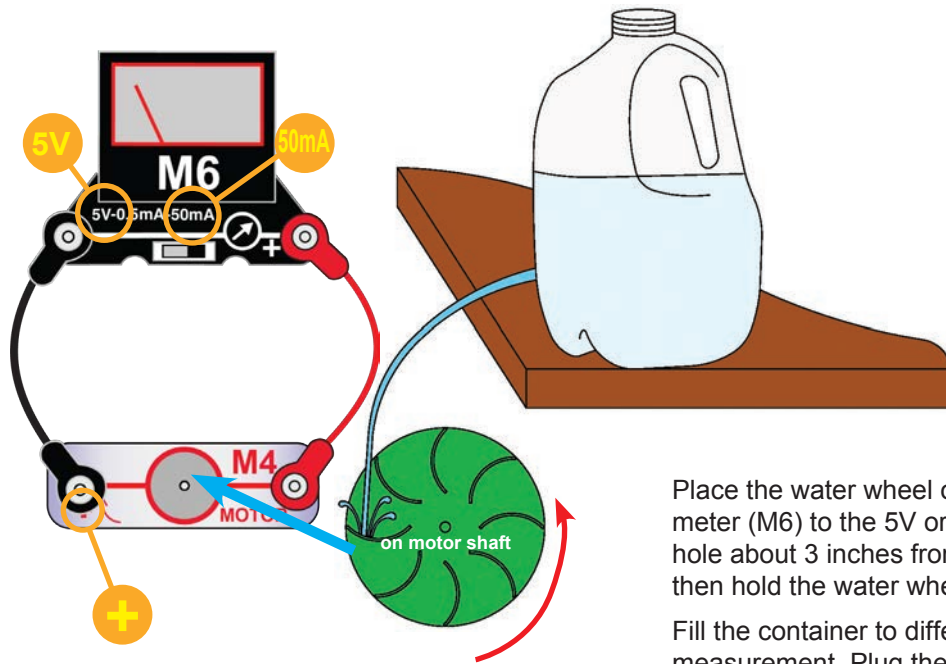

Place the water wheel on the motor (M4) and connect it to the meter (M6), as shown. Set the meter (M6) to the 5V or 50mA setting. Take an empty plastic water or milk container, make a hole about 3 inches from the bottom, place the bottle in a sink or bathtub, fill it with water, and then hold the water wheel next to it and measure the voltage or current produced.

Fill the container to different heights and see how the water pressure affects the meter measurement. Plug the hole with your finger while you fill the container, and try to keep the water wheel in the same position each time.

Your parts might stop working if water gets inside them. Let them dry out and they should be fine.

PROJECT 85 • Water Redirection

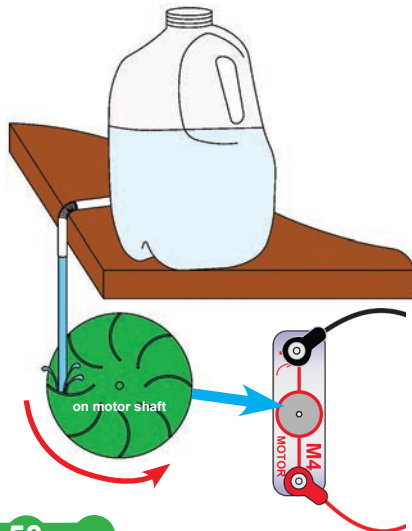

In dam generators, the water to the turbine blades is directed by a series of wicket gates.

Attach a straw (flexible ones work best) from your home to redirect the flow to the Water fan. Try and seal the area around the straw with putty, play dough, scotch tape or other such material. Repeat the meter readings from the previous project and see how much the power has increased.

Raising the water level in the container is just like storing water in a lake next to a dam. A higher water level means more water pressure, which spins the shaft faster, which produces more electricity.

A dam converts the potential energy of the high water into kinetic energy of fast moving water, which is reduced when the water is used to spin the turbine in a generator. The water in Hoover Dam is 500 feet deep at its base and reaches speeds of 85 mph going into the turbine.



PROJECT 86 • One of the Most Powerful Forces in the Universe

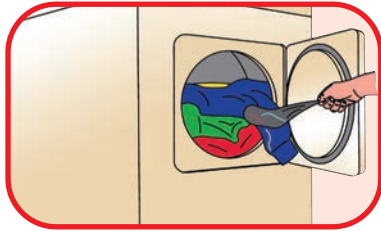

Find some clothes that cling together in the dryer, and try to uncling them.



The crackling noise you hear when taking off a sweater is static electricity. You may see sparks when taking one off in a dark room.



Rub a sweater (wool is best) and see how it clings to other clothes.

Note: This project works best on a cold dry day. If the weather is humid, the water vapor in the air allows the static electric charge to dissipate, and this project may not work.

These effects are caused by electricity. We call this static electricity because the electrical charges are not moving, although pulling clothes apart sounds like static on a radio. When electricity is moving (usually through wires) to do something in another place, we call it an electric current.

Electricity exists everywhere but is so well balanced that you seldom notice it. But sometimes, electrical charges get separated and build up a difference between materials, and sparks can fly. Lightning is the same effect as the sparks between clothes, but on a much greater scale. A cloud holds static electricity just like a sweater.

The static electricity around us is extremely powerful. If we could learn to move and control it, we might have all the energy we need. Maybe someday you will find a way.



PROJECT 87 • Electricity Against Water



Note: This project works best on a cold dry day. If the weather is humid, the water vapor in the air allows the static electric charge to dissipate, and this project may not work.

You need a comb (or plastic ruler) and a water faucet for this project. Run the comb through your hair several times then hold it next to a slow, thin stream of water from a faucet; the water will bend towards it. You can also use a plastic ruler. Rub it on your clothes (wool works best).

Rubbing the comb through your hair builds up a static electrical charge on it, which attracts the water.

PROJECT 88 • Harnessing Static Electricity

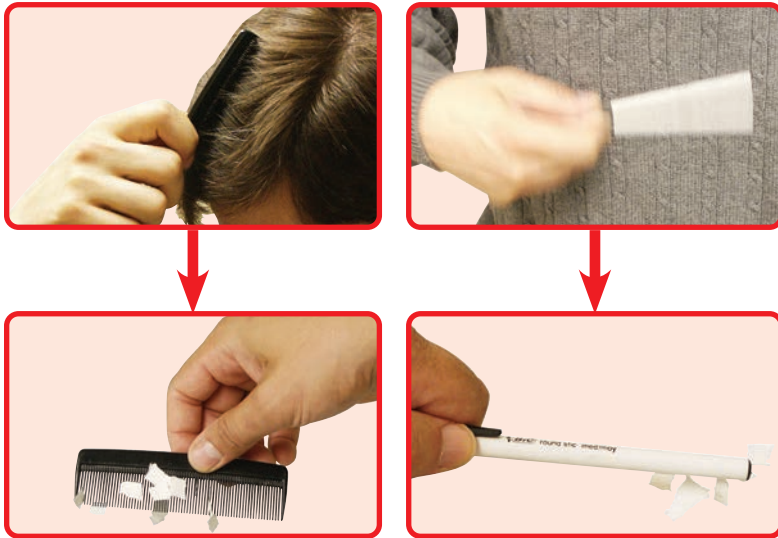

You need a comb (or a plastic ruler) and some paper for this project. Rip up the paper into small pieces. Run the comb through your hair several times then hold it near the paper pieces to pick them up. You can also use a plastic ruler, rub it on your clothes (wool works best).

Rubbing the comb through your hair pulls extremely tiny charged particles from your hair onto the comb. These give the comb a static electrical charge, which attracts the paper pieces.



If you have two balloons, rub them to a sweater and then hang the rubbed sides next to each other. They repel away. You could also use the balloons to pick up tiny pieces of paper.



Take a piece of newspaper or other thin paper and rub it vigorously with a sweater or pencil. It will stick to a wall.



Cut the paper into two long strips, rub them, then hang them next to each other. See if they attract or repel each other.

Electricity is immensely more powerful than gravity (gravity is what causes things to fall to the ground when you drop them). However electrical attraction is so completely balanced out that you don't notice it, while gravity effects are always apparent because they are not balanced out.

Gravity is actually the attraction between objects due to their weight (or technically, their mass). This effect is extremely small and can be ignored unless one of the objects is as big as a planet (like the earth). Gravity attraction never goes away and is seen every time you drop something. Electrical charge, though usually balanced out perfectly, can move around and change quickly.

For example, you have seen how clothes can cling together in the dryer due to static electricity. There is also a gravity attraction between the sweaters, but it is always extremely small.

Some electricity is produced in dams, by harnessing the power of gravity to move water to spin a generator. If instead we could harness the static electricity contained in the water, we would have all the electricity we need.

Note: This project works best on a cold dry day. If the weather is humid, the water vapor in the air allows the static electric charge to dissipate, and this project may not work.

Snappy says to notice how your hair can "stand up" or be attracted to the comb when the air is dry. Wetting your hair dissipates the static charge.

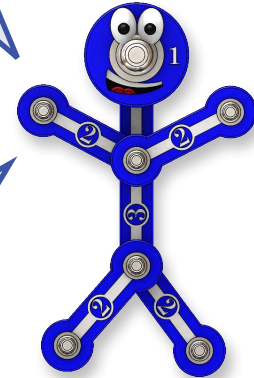

Get a roll of plastic tape. Make some strips about a foot long. Hold their ends so they hang downwards, and slowly bring them close together. See if you can make them touch each other.

PROJECT 89 • Solar Light Clock

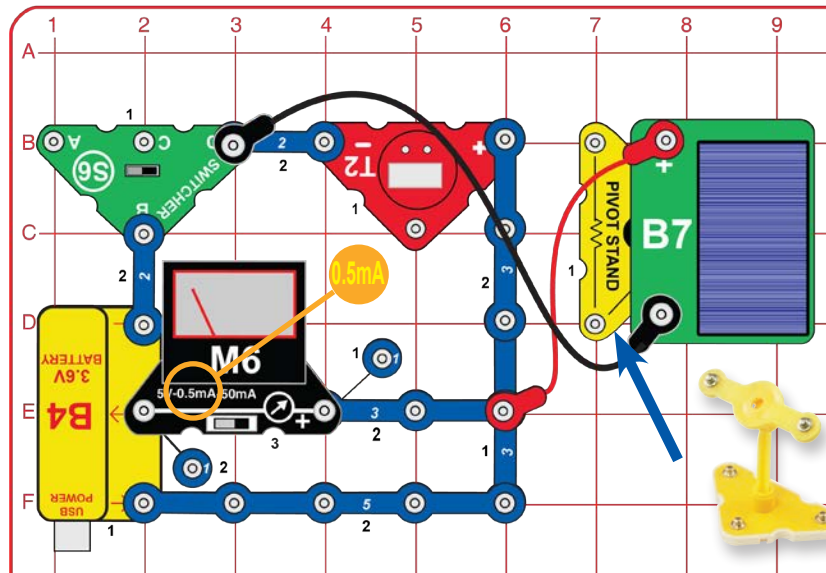

Assemble the pivot, mount the solar cell (B7) on it, and place it next to the circuit as shown. Connect the solar cell to the circuit using the red and black jumper wires. Set the meter to the 0.5mA setting. Set the Switcher switcher (S6) to the left position. Place the circuit so the solar cell is in bright sunlight or close to an incandescent light bulb. The display on the clock (T2) should be on.

Now set the slide switcher to the right position, to add the rechargeable battery to the circuit. See if you can adjust the position of the solar cell on the pivot to make the meter (M6) measure a current.

If your light source is strong enough then the solar cell will charge the battery while running the clock. If your light source is weak then the battery will run the clock.

If you would like to set the time on the clock, see page 4.

See project 3 if you need to recharge the battery (B4).

Solar cells are often used with rechargeable batteries, since the sun isn't always shining. Used together, the solar cell and battery can run the clock for a very long time.



PROJECT 90 • Solar Light Charger

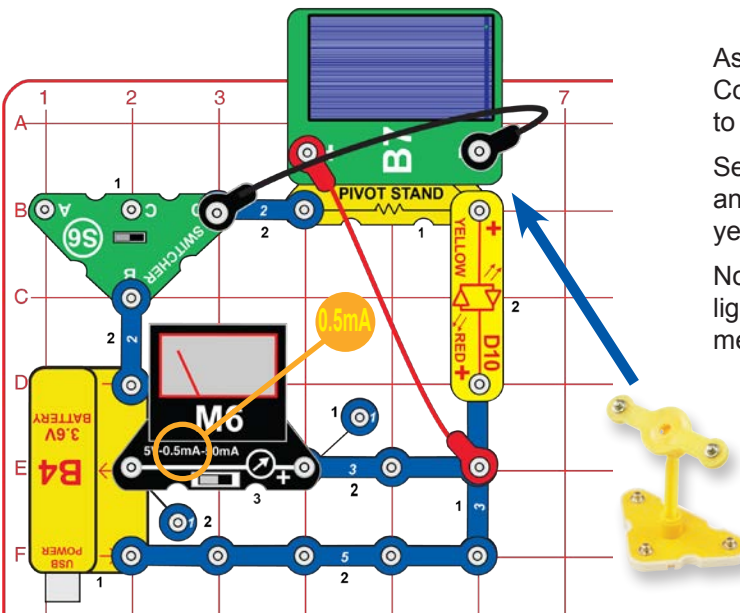

Assemble the pivot, mount the solar cell (B7) on it, and place it in the circuit as shown. Connect the solar cell to the circuit using the red and black jumper wires. Set the meter (M6) to the 0.5mA setting.

Set the switcher (S6) to the left position. Place the circuit in bright sunlight or 3-6 inches from an incandescent light bulb. Adjust the position of the solar cell on the pivot to make the red/yellow LED (D10) brightest.

Now set the switcher to the right position, to add the rechargeable battery to the circuit. If your light source is strong enough then the solar cell will charge the battery, and the meter will measure the charging current. If your light source is weak then the battery will light the LED.

The solar cell only produces a small amount of electricity. The red/yellow LED needs a lot more electricity than the clock, so the solar cell can only run the LED and charge the battery if the light source is very strong.



PROJECT 91 • Solar Light Row

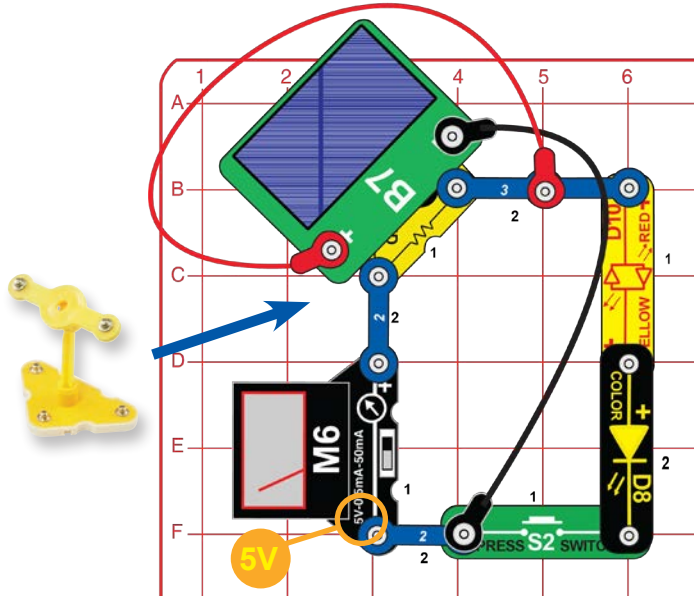

Assemble the pivot, mount the solar cell (B7) on it, and place it in the circuit as shown. Connect the solar cell to the circuit using the red and black jumper wires. Place the circuit so the solar cell is in bright sunlight or close to an incandescent light bulb. Set the meter (M6) to the 5V setting.

The meter is measuring the voltage produced by the solar cell. Adjust the position of the solar cell to make the highest voltage you can. Now push the press switch to run the yellow/red and color LEDs (D10, D8) with the solar cell. Notice how the voltage produced drops a little when the LEDs are connected, but not as much as when only the yellow/red LED was in the circuit (the Solar Power project).

Note: The voltage produced is actually twice that shown on the meter (so a 3V reading is really 6V), because a resistor in the pivot stand is changing the scale.

Having both LEDs in series resists the flow of electric current more than just one, making it easier for the solar cell to run them.

PROJECT 92 • Crank Support

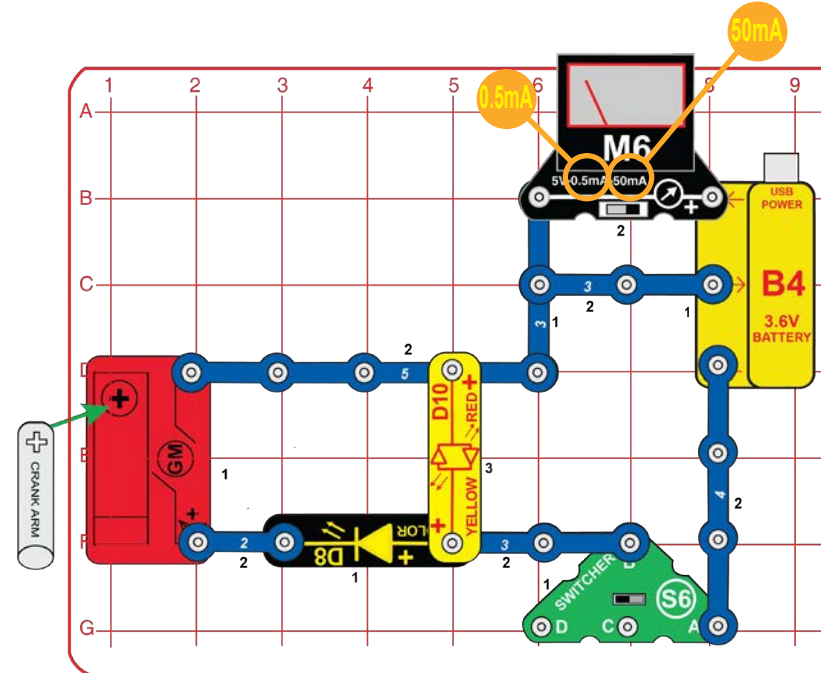

Build the circuit by setting up the parts as shown. Set the meter (M6) to the 0.5mA or 50mA setting. Set the switcher switch (S6) to the right position to connect the rechargeable battery (B4) to the red/yellow LED (D10). If the battery is charged, the LED will light and the meter will show that an electric current is flowing out of the battery. The 0.5mA meter scale will show a high current while the 50mA scale may show little or no current.

Turn the handle on the crank arm on the geared motor (GM) counter-clockwise (opposite to the direction a clock turns) to have it take over powering the red/yellow LED. When you crank fast enough, the color LED (D8) will turn on (indicating that current is flowing through the geared motor) and the meter will no longer show any current flowing from the battery.

Warning: the hand crank is sturdy but not indestructible. If you push hard on it or crank it really fast you may break it.

See project 3 if you need to recharge the battery (B4).

Think of the red/yellow LED as an emergency light in your home. When the main power goes out, it can run for a while on battery backup or a hand crank generator.

PROJECT 93 • Hand Lights

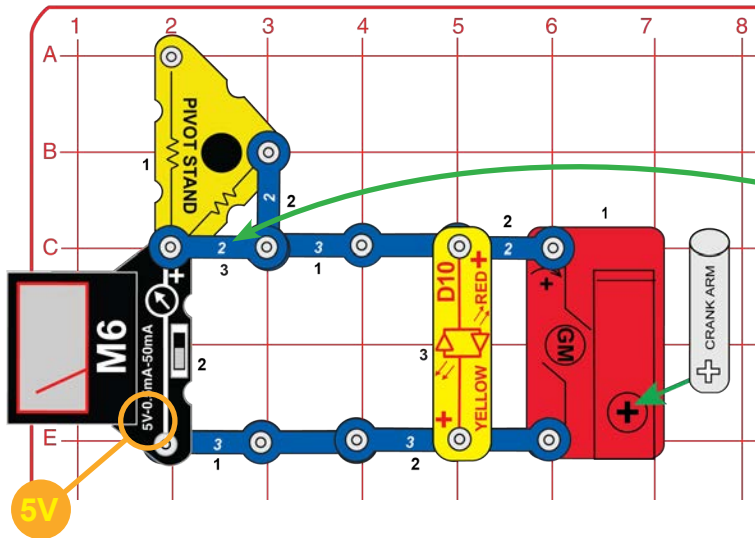

Set the meter (M6) to the 5V setting and turn the crank arm on the geared motor (GM). Turning clockwise will light the red/yellow LED (D10) red while the meter shows the voltage produced. Turning counter-clockwise produces electricity flow in the opposite direction, so the LED lights yellow.

You can probably turn the crank fast enough to measure more than 5V on the meter. Remove the 2-snap wire across base grid locations C2-C3 on level 3. This puts a 10KW resistor in the pivot stand in series with the meter, changing its voltage scale. Now turn the crank but double the voltage shown on the meter (so 4V is really 8V).

The hand crank has a gearbox, which allows a motor in it to spin faster and with less force than you turn the crank. The faster the motor spins, the more electricity is produced.



PROJECT 94 • Hand Noise

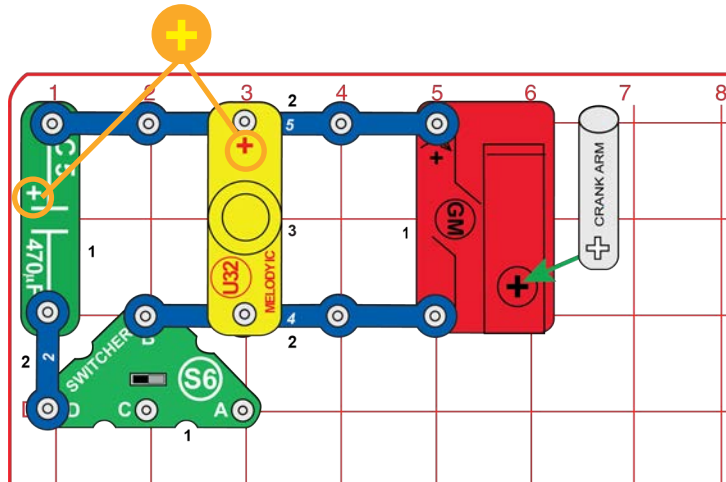

Turn the crank arm on the geared motor (GM) clockwise. The melody IC (U32) makes noise. Set the switcher (S6) to the left position to make the sound a little louder.

If you are out in the wilderness, you can use a hand crank and horn to sound an alarm.

The electricity produced by the hand crank is unstable, due to the design of the motor inside it and because you can't turn the crank in a steady manner. The 470mF capacitor (C5) acts like a filter to stabilize the electricity, which makes the melody IC work better.

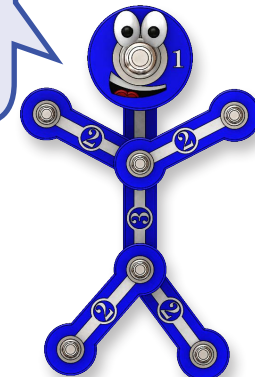

PROJECT 95 • Heavy Fan

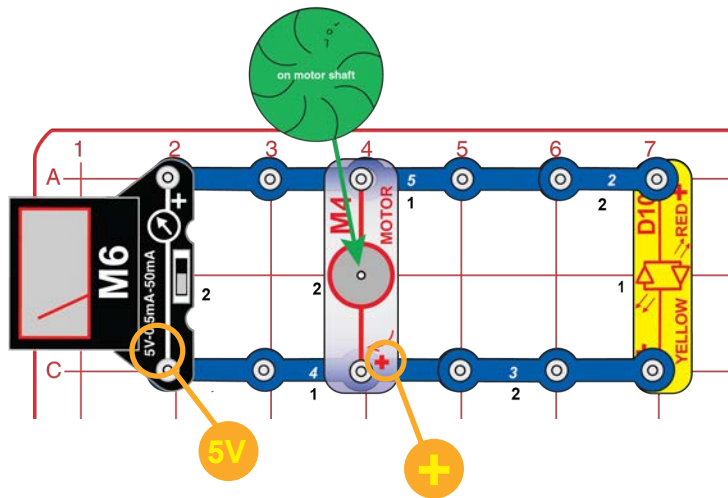

Build the circuit as shown, with the water wheel on the motor. Set the meter (M6) to the 5V setting. Blow on the water wheel, aiming the air into the “curves” on the fan. Watch the meter to see the voltage produced, and the red/yellow LED (D10) will light red.

If you blow on the opposite side of the fan curves, the fan will not spin as easily. The LED will light yellow if you blow hard enough.

The water wheel was made to use with water, but wind can push it too.



PROJECT 96 • Remote Heater

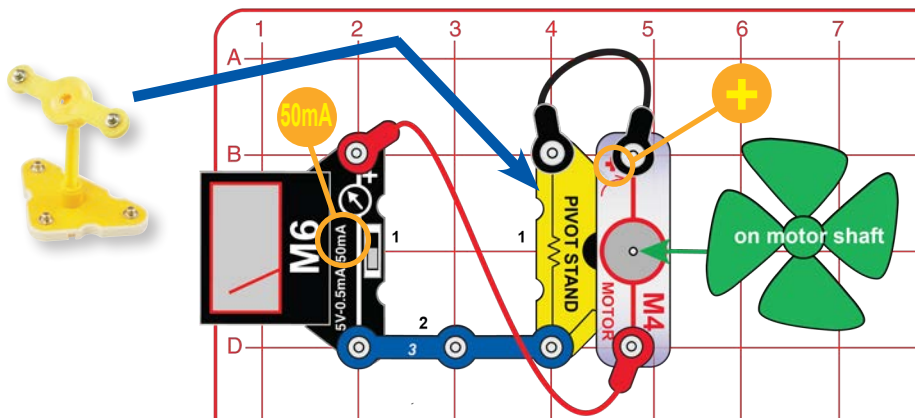

Build the circuit as shown, with the motor (M6) on the pivot and the wind fan on the motor. Set the meter (M6) to the 50mA setting. Blow on the fan or place it in a strong wind.

This circuit uses wind power to heat a 47W resistor in the pivot stand. The resistor is getting warmer, but you will not notice it through the plastic case. The meter measures the current.

You can replace the motor with the solar cell (B7, red wire to “+” side) to heat the resistor using sunlight.

Most of the energy used to make electricity eventually becomes heat. Many computers and TVs have fans to circulate the air to prevent components from overheating. LEDs convert some of the electricity to light, and the rest becomes heat. The radio and horn convert some electricity to sound waves, and the rest becomes heat.

You can help to heat your home by putting a windmill on your roof and using it to heat a resistor in your living room.

Electricity is great for transporting energy. Here electricity is used to move energy harnessed from the wind to the resistor where it is used. The electrical transmission lines in your neighborhood transport the electricity from a power plant to your home.



PROJECT 97 • Remote Water Heater

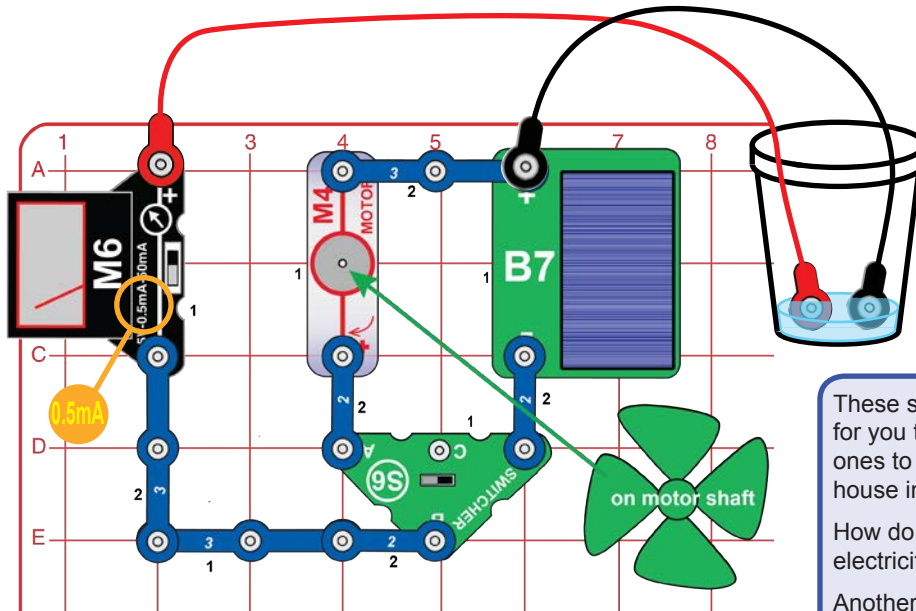

Build the circuit, place the wind fan on the motor (M4), and set the meter (M6) to the 0.5mA scale. Place the circuit so wind is blowing on the fan or sunlight is shining on the solar cell (B7). Set the switcher (S6) to the left position if you have wind or to the right position if you have sunlight. Connect the jumper wires to the circuit and place the other ends in a cup of water, make sure the metal parts aren't touching each other.

Your power source (wind or sun) is making an electric current flow through the water, and the meter measures the current. As the current flows through the water, the water is warmed.

These small wind and solar power sources may not produce enough heat for you to notice the water getting warmer, but you could use more powerful ones to heat up a lot of water. You could then pump the water around your house in pipes to use the wind or solar heated water to warm up your house. How do you harness the wind to heat your house? It is easy when you use electricity to help.

Another way to harness sunlight to heat homes is by using sunlight to heat water, then pumping the water around the house.

PROJECT 98 • Electrical Material Checker

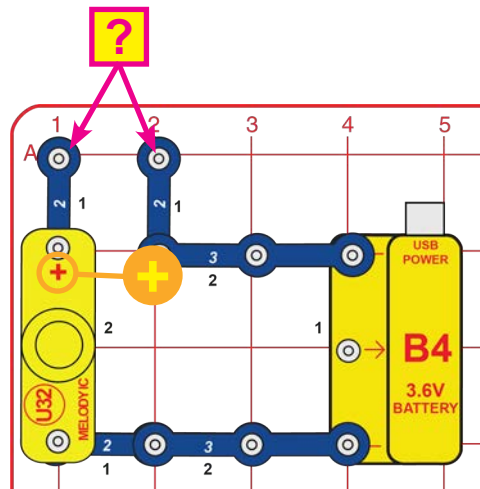

See project 3 if you need to recharge the battery (B4).

Build the circuit shown, and touch various materials between the snaps marked with .

The melody IC (U32) will signal for materials that are good at transporting electricity. Try string, the electrodes, a shirt, plastic, paper, wood, or anything in your home.

Many electronic test instruments test wires and connections using probes and a sound device like you did here. A sound device is used so the user can focus his attention on where he puts the probes without looking at a display.

You can replace the melody IC with the meter (0.5mA setting) or one of the LEDs (D8 & D10) to make a visual continuity checker.

Some materials, such as metals, have very low resistance to electricity and will turn on the horn. These materials are called **conductors**.

Other materials, such as paper, air, and plastic, have very high resistance to electricity. These will not turn on the horn. These materials are called **insulators**.

Copper is one of the best conductors ever found so it is used for most electrical wires. Plastic is a very good insulator so it is used around copper wires to prevent electricity from getting in or out of the wire.

PROJECT 99 • Morse Code

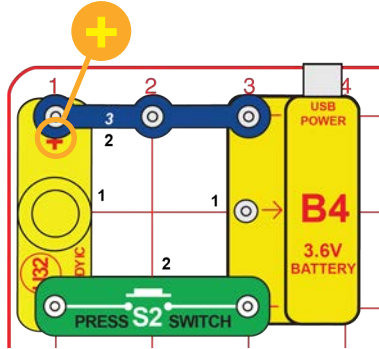

Build the circuit and push the switch (S2) several times to send secret messages to your friends using Morse Code.

If the melody IC (U32) was located 10 miles away and connected to the switch and battery (B4) using really long wires, then you could still use it to send messages.

See project 3 if you need to recharge the battery (B4).

Morse Code: The forerunner of today's telephone system was the telegraph, which was widely used in the latter half of the 19th century. It only had two states - on or off (that is, transmitting or not transmitting), and could not send the range of frequencies contained in human voices or music. A code was developed to send information over long distances using this system and a sequence of dots and dashes (short or long transmit bursts). It was named Morse Code after its inventor. It was also used extensively in the early days of radio communications, though it isn't in wide use today. It is sometimes referred to in Hollywood movies, especially Westerns.

MORSE CODE			
A	.. _	N	_ .
B	... _	O	... _ _ _
C	.. _ .	P	.. _ . .
D	.. _ .	Q	.. _ . _ _
E	. _ _	R	. _ . _
F	.. _ . .	S	... _ _
G	_ _ . .	T	_ _ .
H	.. _ . .	U	.. _ _
I	.. .	V	.. _ . .
J	. _ _ _	W	.. _ . _
K	_ . _ .	X	.. _ . _
L	.. _ . .	Y	.. _ . .
M	_ _ .	Z	_ . _ . .
		Period	.. _ . .
		Comma	.. _ . .
		Question	.. _ . .
		1	.. _ . .
		2	.. _ . .
		3	.. _ . .
		4	.. _ . .
		5	.. _ . .
		6	.. _ . .
		7	.. _ . .
		8	.. _ . .
		9	.. _ . .
		0	.. _ . .

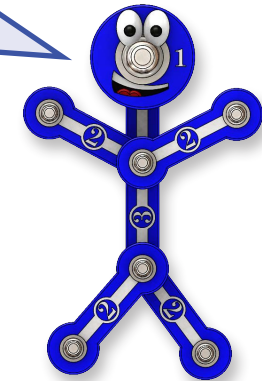

PROJECT 100 • Morse Light

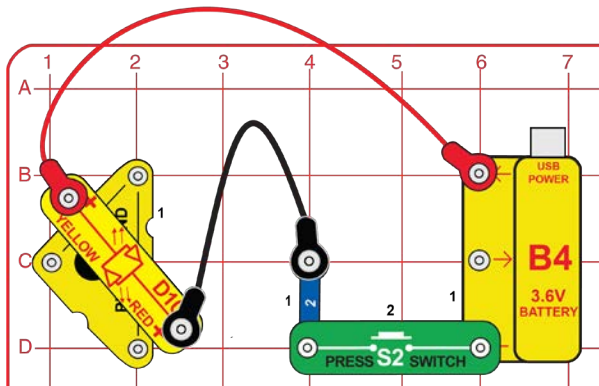

Build the circuit as shown, with the red/yellow LED (D10) on the pivot. Point the LED towards your friends and push the switch (S2) several times to send messages to your friends using Morse Code.

You could use this system to send messages during a noisy concert, or out in the wilderness where your cell phone won't work.

During World War II Navy ships sometimes communicated by flashing Morse Code messages between ships using searchlights (because radio transmissions might reveal their presence to the enemy). Years ago, Native Americans would send messages to other tribes using smoke signals and a special code.

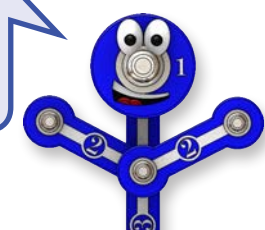

PROJECT 101 • Everything Circuit

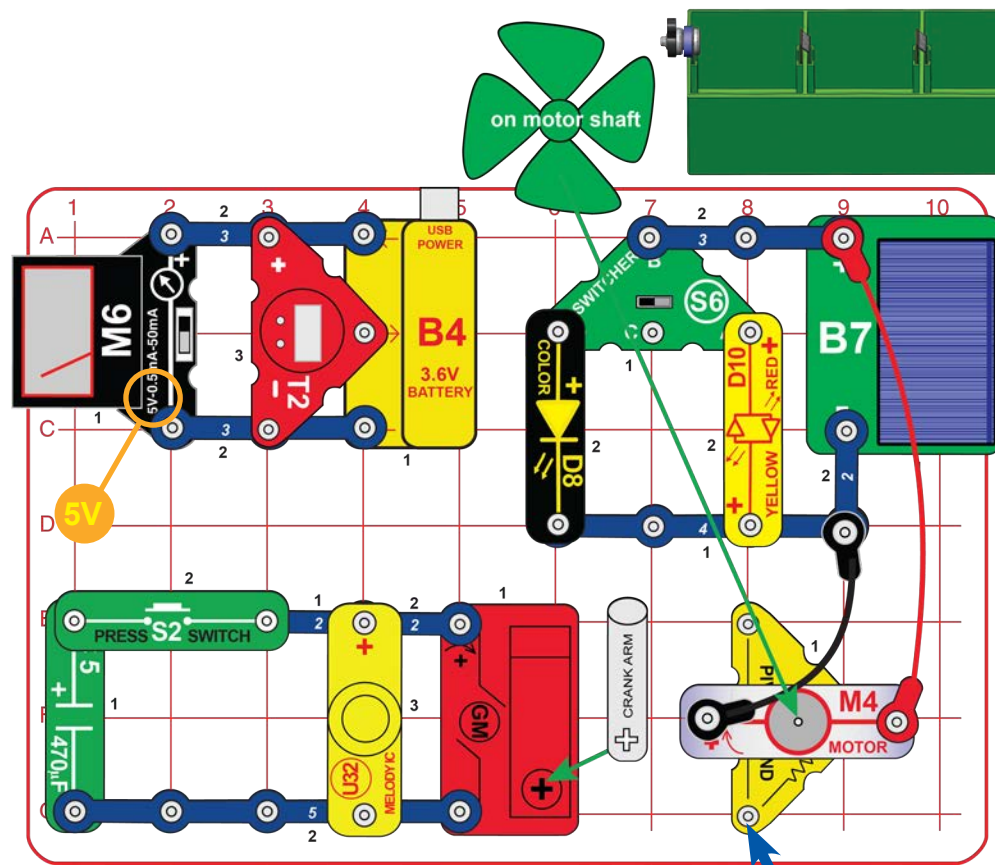

This project combines several circuits to demonstrate what you can do with Snap Circuits® Green Energy. This circuit may be shown on your box or manual cover.

Assemble the circuits shown. Set the meter (M6) to the 5V setting and place the crank arm on the geared motor (GM). See page 4 if you would like to set the time on the clock (T2).

The battery (B4) runs the clock, while the meter (M6) monitors the battery voltage. Turn the crank arm clockwise to run the melody IC (U32); pushing the press switch (S2) makes the sound louder. Place the solar cell (B7) in sunlight or near an incandescent light bulb to light one of the LEDs (D8 & D10), depending on the switcher (S6) position.

Note: You should not connect the jumper wires to the LED circuit if you want to run them using the solar cell.

The LEDs may also be powered by wind or liquids. Assemble the pivot stand and place the motor with wind fan on it. Connect it to the circuit near the solar cell using the red & black jumper wires. Blow on the wind fan or place it in a strong wind to use it to light the LEDs.

To run the LEDs using liquid, assemble the liquid energy source using the instructions on page 4. Move the red and black jumper wires from the windmill motor to the electrodes (red wire to the copper electrode, black wire to zinc electrode). Fill the compartments with cola or juice. The solar cell is still connected to the circuit, so you may cover it to prevent it from helping the liquid run the LED.

You may re-arrange the LEDs, clock, and melody IC between the different mini-circuits, but some energy sources may not be able to operate them.

See project 3 if you need to recharge the battery (B4).

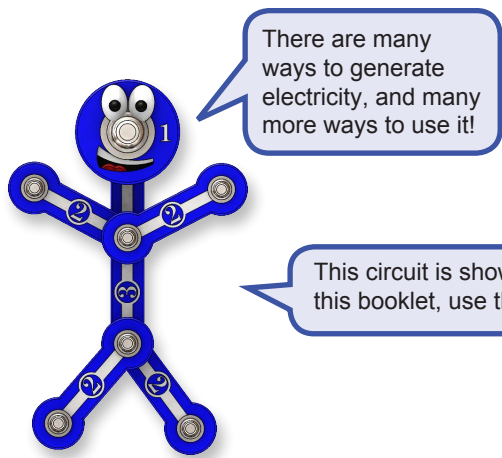

There are many ways to generate electricity, and many more ways to use it!

This circuit is shown on the cover of your box and this booklet, use that picture to help in building it.

PROJECT 102 • Motor Status LEDs

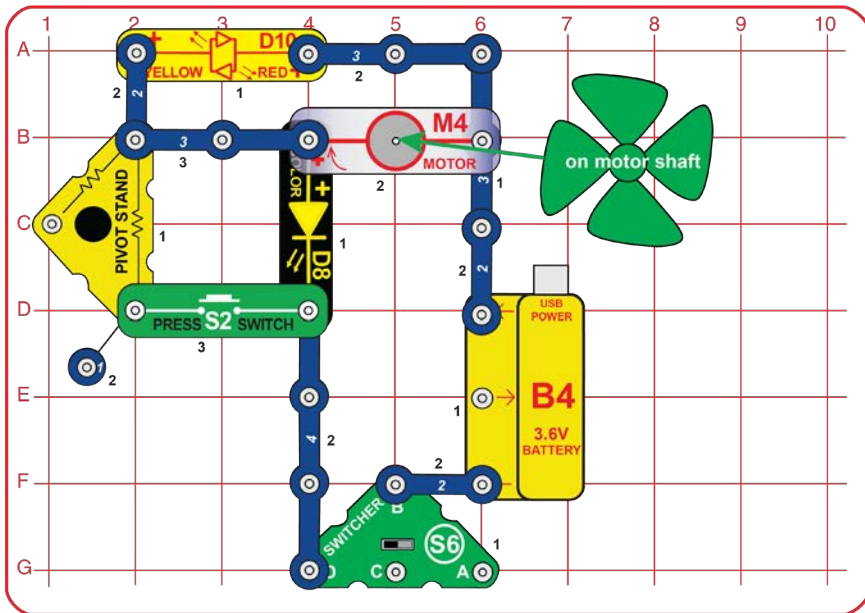

In this circuit we use the LED's (D8 & D10) to indicate if the motor (M4) is spinning. Set the switcher (S6) to the left position, the color LED lights, indicating the motor is not spinning. Pushing the press switch (S2) bypasses the color LED, and it turns off. The voltage across the motor and red/yellow LED increases, so they turn on.

See project 3 if you need to recharge the battery (B4).

Check your thermostats at home and see if an LED or fan symbol lights when the heater or air-conditioner is on.

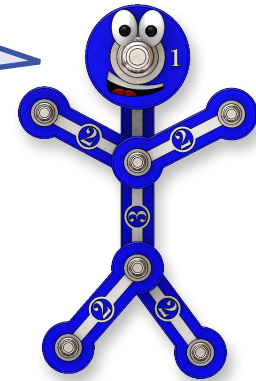

PROJECT 103 • Energy Converter

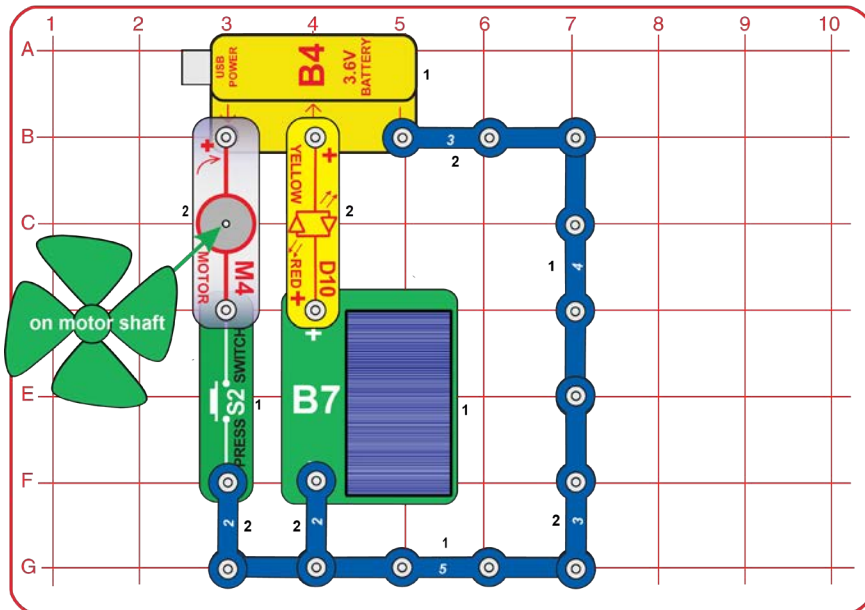

In this project you'll convert one form of energy to another. Place the solar cell in sunlight or about 12 inches from an incandescent light bulb of 60W or more. Adjust the light on the solar cell to make the red/yellow LED (D10) brightest. The solar cell converts light energy into electrical that lights the LED and charges the battery (B4).

The electrical energy charges the battery, converting it into a chemical form. When you press switch S2, chemical energy in the battery makes electrical energy, which runs the motor (M4) and fan. The spinning motor shaft and fan are another form of energy called motion.

If you prefer, you can mount the solar cell on the pivot stand, connect it to the circuit using the red & black jumper wires, and then adjust the pivot so the solar cell faces the light.

PROJECT 104 • Energy Conversion

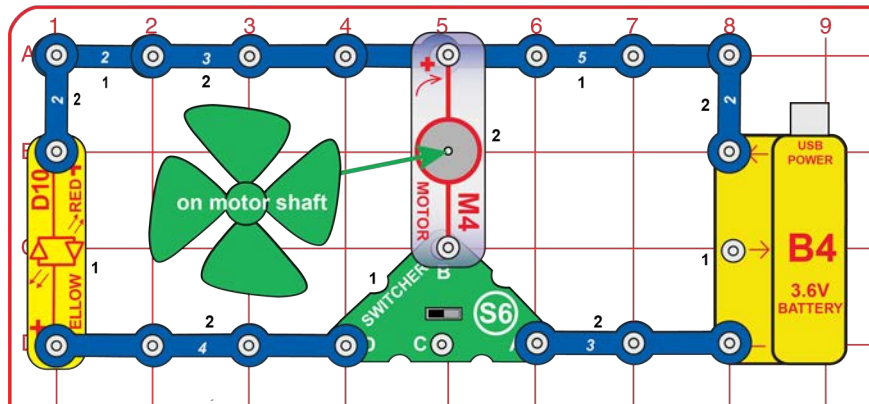

Set the switcher (S6) to the right position. Some of the chemical energy in the battery becomes electricity, which is converted into mechanical energy of motion by the motor (M4).

Now set the switcher to the left position. Some of the mechanical energy in the spinning motor shaft and fan generates electricity, which travels to the LED (D10), where it becomes light. The LED will only light briefly.

Part B: Replace the motor with the color LED (D8) or the melody IC (U32). Set the switcher to the right position. Now the chemical energy in the battery becomes light energy or sound energy (air pressure variations).

Part C: Replace the battery with the geared motor (GM) and crank arm. Now you can convert mechanical energy of motion to chemical energy in the battery, then to motion, light, or sound.

See project 3 if you need to recharge the battery (B4).

PROJECT 105 • Small Energy Conversion

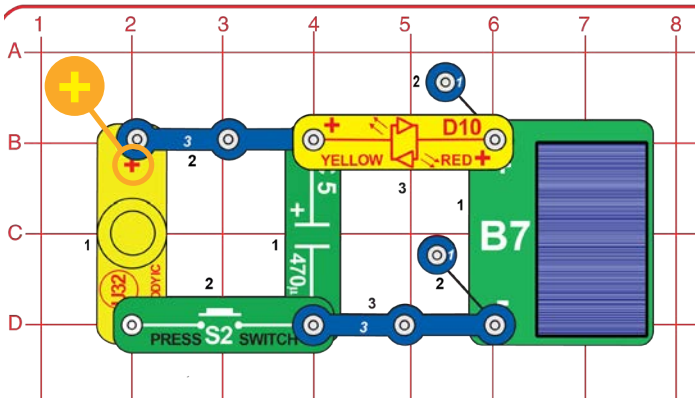

The capacitor stores energy as an electric field, similar to the magnetic field of a magnet. It can only store a small amount of energy in this way.



Build the circuit shown, and place the solar cell (B7) in sunlight or close to an incandescent lamp for a few seconds. The LED (D10) should light briefly. The solar cell converted some light energy into electrical energy, which was stored in the 470mF capacitor (C5).

Press the switch (S2). The melody IC (U32) makes a brief sound. The electrical energy in the capacitor was converted to sound waves (variations in air pressure) by a speaker in the melody IC.

Part B: Replace the melody IC with the color LED (D8). Now the color LED converts the energy stored in the capacitor back to light.

Part C: Replace the color LED with the motor (M4) and wind fan. Now the energy stored in the capacitor is converted to mechanical motion by the motor. The fan will not move very much.

PROJECT 106 Mechanical Energy Conversion

Replace the solar cell with the geared motor and crank arm. Now you can convert mechanical energy to electrical energy in the capacitor, then to sound, light, or motion.

PROJECT 107 • Generator

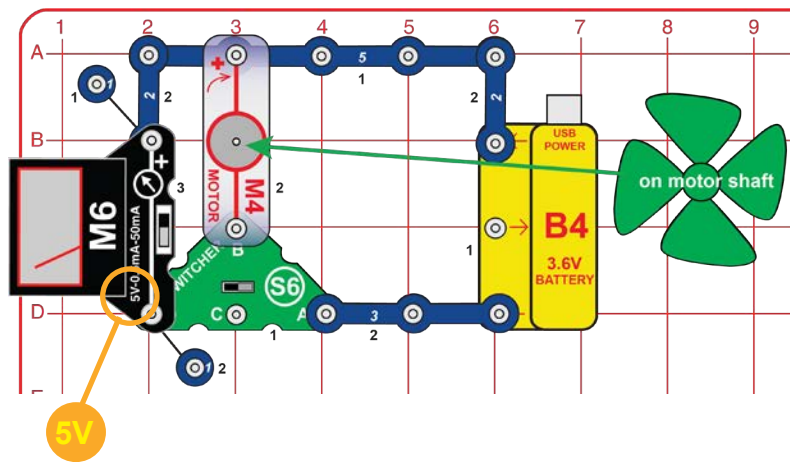

Set meter (M6) to the 5V setting and set the switcher (S6) to the right position. Some of the chemical energy in the battery becomes electricity, which is converted into mechanical energy of motion by the motor (M4).

Now set the switcher to the left position. Some of the mechanical energy in the spinning motor shaft and fan generates electricity, which is measured as voltage on the meter.

Keep the switcher in the left position and spin the fan clockwise with your finger. The meter measures the voltage produced.

See project 3 if you need to recharge the battery (B4).

A motor uses electricity to produce mechanical motion. A generator uses mechanical motion to produce electricity.

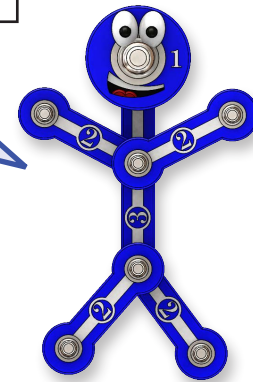

PROJECT 108 • Clock with Memory

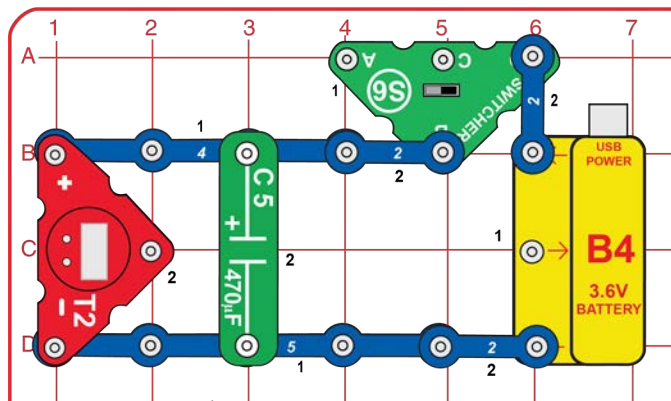

Build the circuit, and set the switcher (S6) to the right position to turn on the clock. If you turn off the switch or disconnect the power source (the B4 battery), the clock will still work for a while. The 470mF capacitor (C5) stores enough electricity to run the clock for a while during power disruptions. If you remove the capacitor, the clock will turn off when you turn off the switch.

See page 4 if you would like to set the time.

Many clocks use capacitors or small batteries as backups in case the power goes out for short periods.



PROJECT 109 • Saving Energy

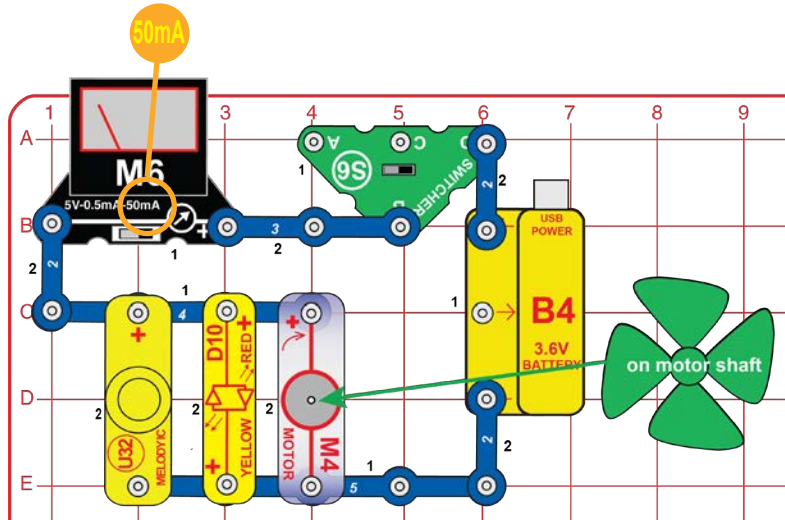

Build the circuit shown. Set the meter to the 50mA setting. Set the switcher (S6) to the right position. The battery operates the melody IC (U32), LED (D10), and motor (M4), just like batteries operate stuff in your home. The meter shows how much current is used to operate them; the more current is used, the faster the battery will run out.

You can make the battery last longer if you turn off some things. Remove the melody IC, LED, or motor from the circuit, and see how much the current drops. Then remove another. Some devices use more current than others, so it helps most if you disconnect the highest current device - find out which one it is. You can also replace the motor with the geared motor (GM) or clock (T2) to see how their current compares to the other devices.

See project 3 if you need to recharge the battery (B4).

Reducing how much energy we use is just as important as finding new sources of clean energy.



PROJECT 110 • Energy Transmission Loss

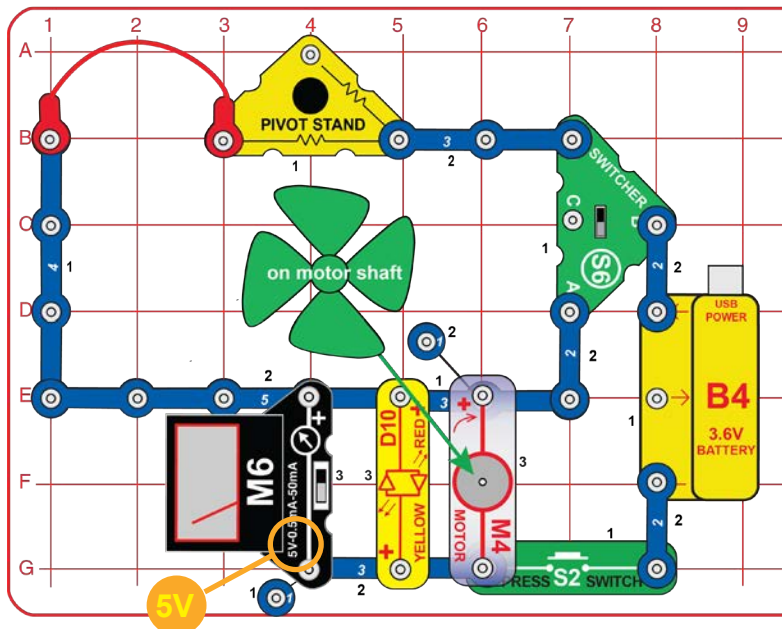

Set the switcher (S6) to the top or bottom position and push the press switch (S2); the motor (M4) spins the fan, the LED (D10) lights, and the meter (M6) measures the voltage across them.

If the switcher is in the bottom position, the electric current takes the short path to the meter/LED/motor. If the switcher is in the top position, the current takes the longer path, and the voltage available at the meter/LED/motor is lower due to more resistance in the path.

Remove the LED or motor and see how the voltage changes. If less current is used, less voltage will be lost along the way.

Electrical wires have low resistance, but when you are transporting large amounts of electricity over large distances (such as between power plants and cities), even low resistance causes large power losses. In this circuit a resistor in the pivot stand simulates having a very long wire.

When electric power companies transport electricity long distances (like between power generating plants and cities), they use high voltages and low currents since this reduces power loss in the wires. Transformers convert this to 120V, which is supplied to homes and offices.



PROJECT 111 • Water Timer

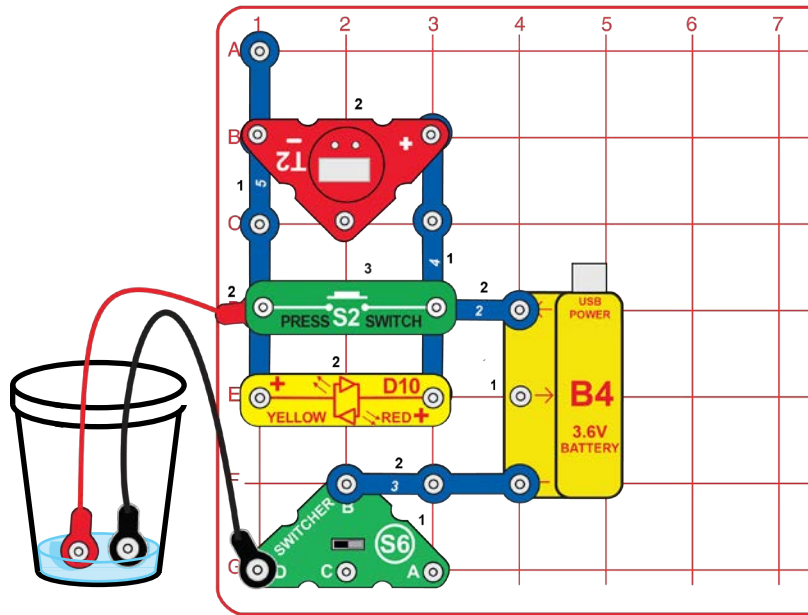

Set the switcher (S6) to the left position. Place the loose ends of the red & black jumper wires into a cup of water without the metal parts touching. The LED (D10) should light dimly and the clock (T2) should run, but it depends on your local water supply. Add salt to the water if they are off or dim to make them brighter.

Remove the water, and push the press switch (S2) to reset the clock. Place the empty cup under a faucet or a gutter drain. When water goes into the cup, the clock will start. If you go away and return, you can use this timer to see how long ago water entered the cup.

See project 3 if you need to recharge the battery (B4).

PROJECT 112 • Sun & Wind Light

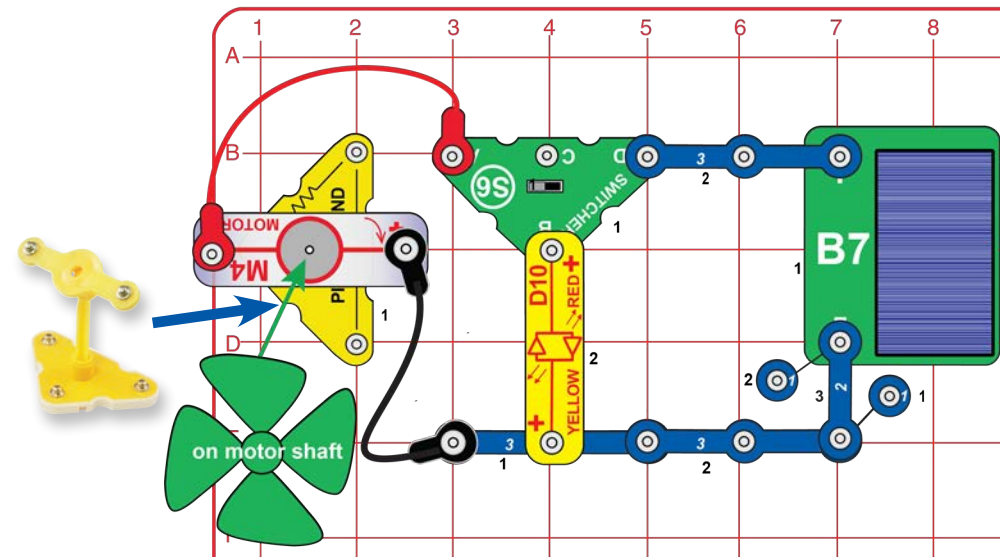

Build the circuit shown, with the motor mounted on the pivot stand like a windmill. Use either sunlight or wind power to run the red/yellow LED (D10). Set the switcher (S6) to the left to use wind power, or to the right to use solar power.

During the day, the sun powers the LED using the solar cell. At night, the wind powers the LED. This circuit does not consume any fuel, and causes no pollution.

PROJECT 113 • Hybrid

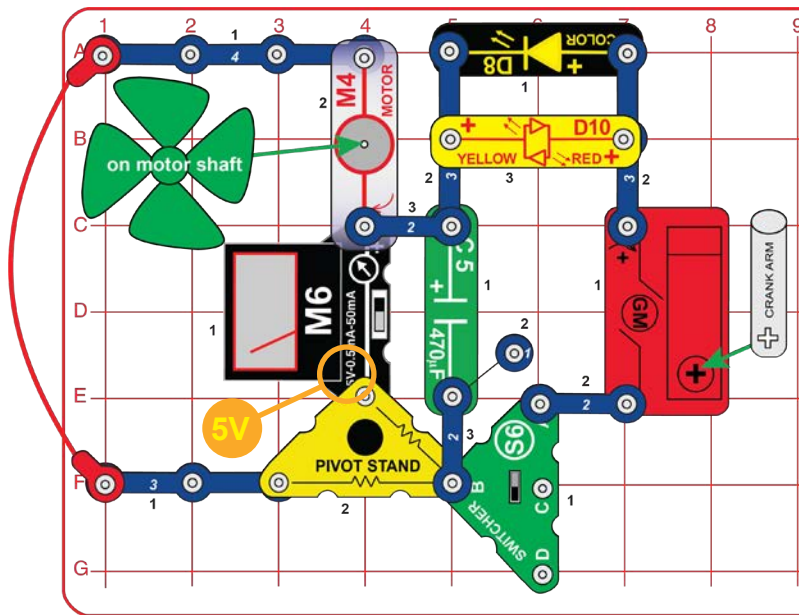

Set the switcher (S6) to the top position and turn the crank arm on the geared motor (GM). The LEDs (D8 & D10) light, the meter measures the voltage, and the fan spins.

The meter scale is 10V (not 5V), due to a scaling resistor in the pivot stand.

The motor is powered by the hand crank or stored energy from the 470mF capacitor (C5). It might be called a hybrid, because it runs on power from either source. However, the capacitor does not store much energy, so it will run the motor for only a very short time. If the rechargeable battery were used here, the motor would run for much longer.



PROJECT 114 • Hybrid Car Concept

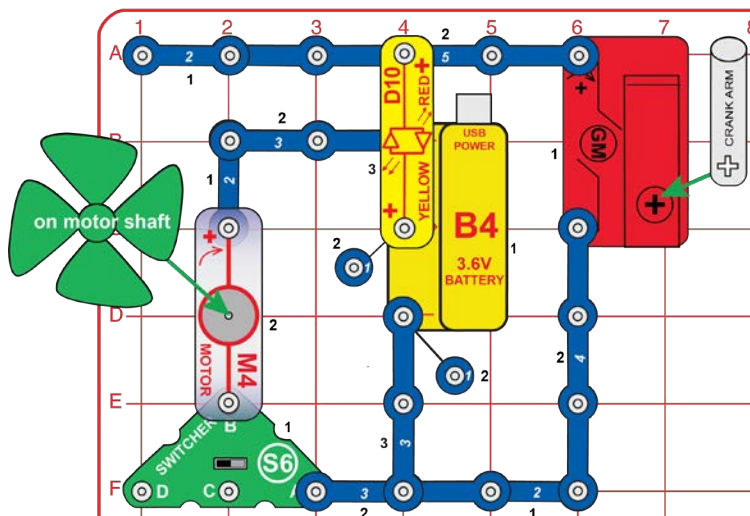

Set the switcher (S6) to the left position and turn the crank arm on the geared motor (GM). The LED (D10) lights when the crank is charging the battery (B4).

Set the switcher to the right position to run the motor (M4) using the battery. If you turn the crank now, it will both charge the battery and run the motor.

This circuit demonstrates the concept of hybrid cars. A power source (the hand crank is used here) charges a battery (B4 here) in a car. The car has an electric motor (not a gasoline powered motor), which is powered by electricity from the battery. Some electric cars also have gasoline powered motors as backups, in case you are driving a long distance and your battery runs out of charge.



PROJECT 115 • Solar Fun

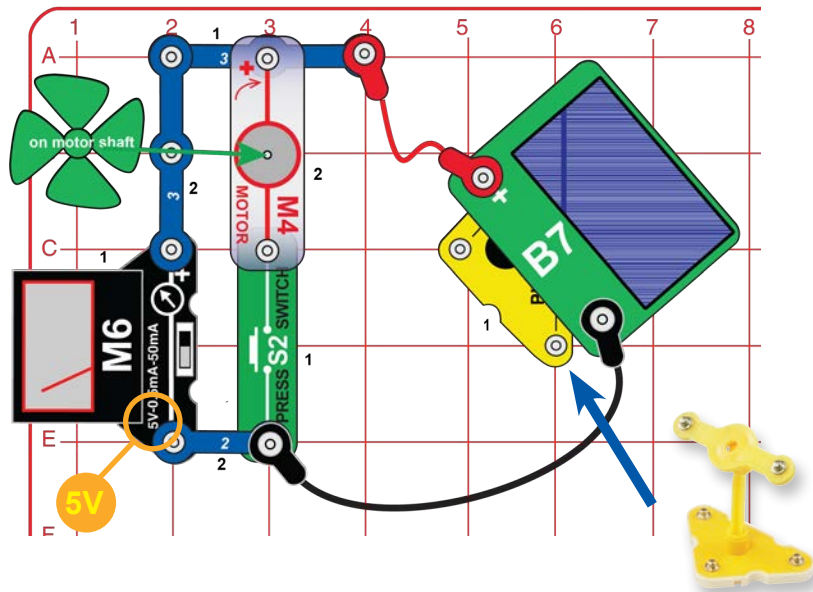

Mount the solar cell (B7) on the pivot stand as shown, and place it in sunlight or near an incandescent lamp. The meter (M6) measures the voltage produced.

Press the switch (S2) to turn on the fan (the M4 motor), you may need to give it a push to get it started. The meter shows the voltage is much lower now with the solar cell running the fan.

The solar cell cannot produce as much current as the fan needs, so the voltage drops.

The same thing happens with water. A pump might push water through a narrow pipe at high pressure, but if you connect the same pump to a much larger pipe, the pressure drops because the pump can only push so much water.

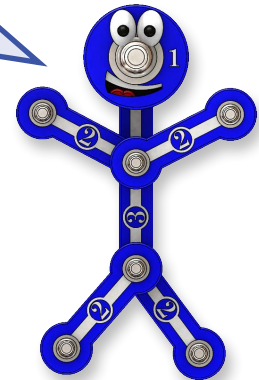

PROJECT 116 • Triple Current Meter

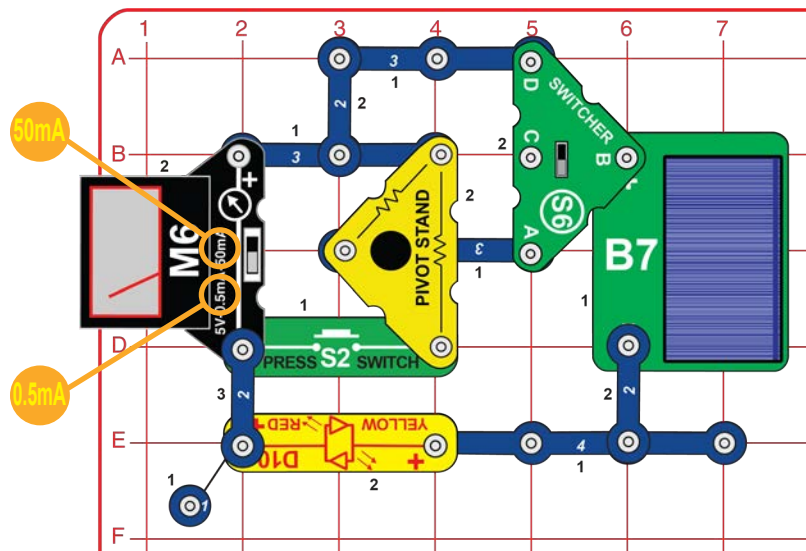

Build the circuit shown. This circuit measures current using several scales on the meter (M6). Set the switcher (S6) to the top position. Place the solar cell (B7) in sunlight or near an incandescent lamp, and vary the light on it. Use the 0.5mA or 50mA settings on the meter to measure the current through the LED (D10).

If the current is too high to measure on the 0.5mA setting and too low to measure on the 50mA setting, use the 0.5mA and push the press switch (S2); this uses a resistor in the pivot stand to change the scale to 5mA.

Set the switcher to the bottom position. This places a high resistor (in the pivot stand) in series with the LED. Measure the current now.

If you don't have a suitable light source, you can use the battery (B4) in place of the solar cell.

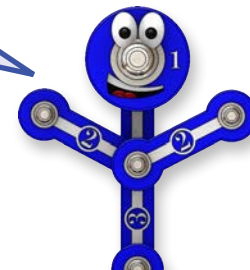

PROJECT 117 • Hand Charger

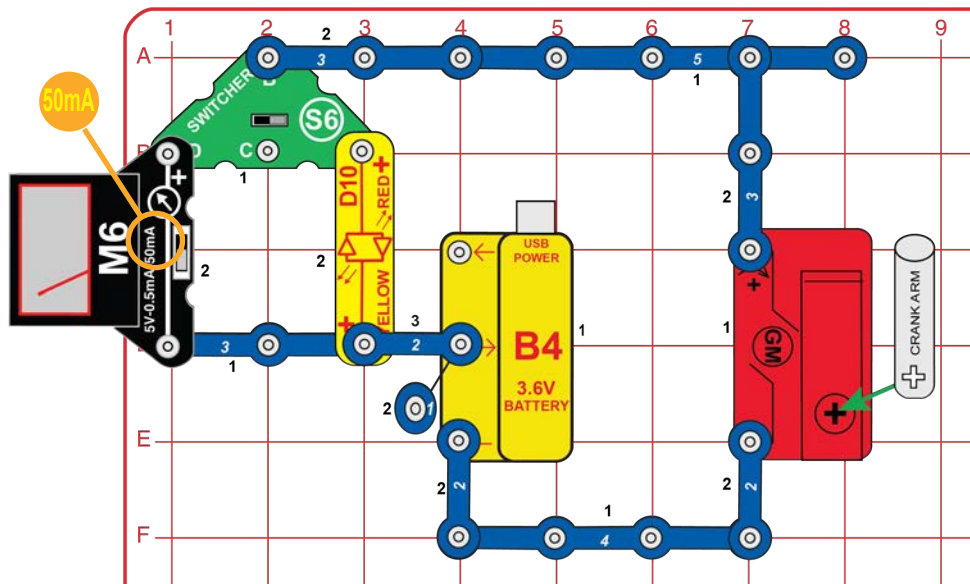

Use the crank arm to charge the battery (B4), the meter (M6) or LED (D10) show how fast you are charging it.

PROJECT 118 • Parallel Cranking

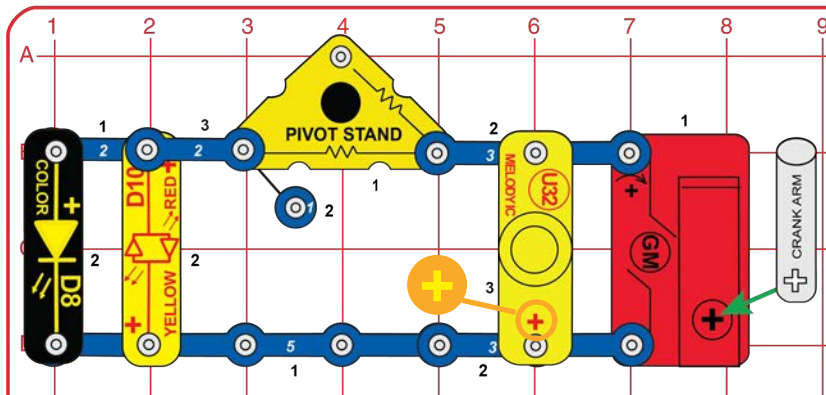

Turn the crank arm on the gearedmotor (GM) slowly clockwise, just enough to turn on the red/yellow LED (D10, which will be red) and make the color LED (D8) show red. Then crank faster, until the color LED also shows green and blue brightly.

If you turn the crank counter-clockwise the red/yellow LED is yellow and the melody IC (U32) plays a tune, but the color LED will not light.

The yellow LED needs a little more voltage to turn on, but can get much brighter. LEDs are manufactured with two regions of permanent electrical charge. Once the voltage exceeds a turn-on level, the resistance becomes very low in one direction, and some energy is emitted as light.

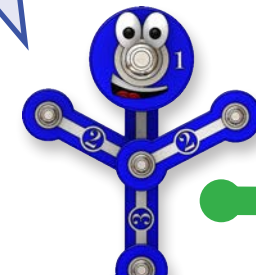

PROJECT 119 • Hard to Crank

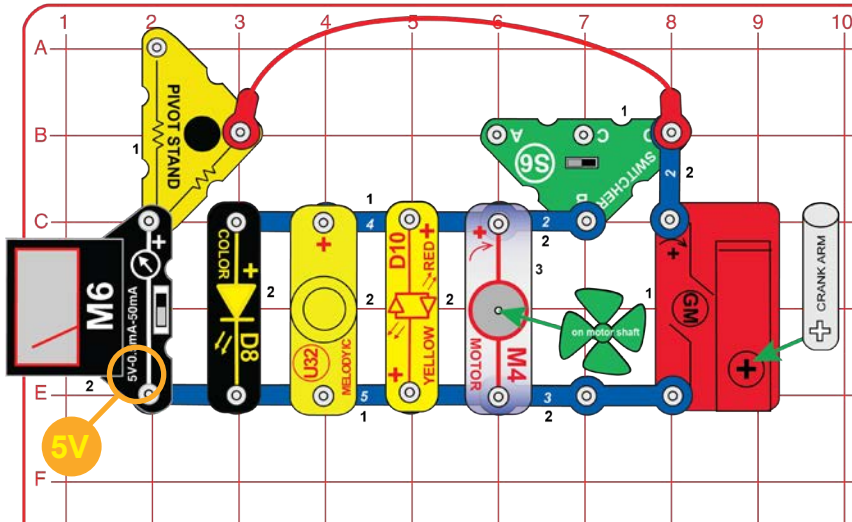

Set the switcher (S6) to the left position, and turn the crank arm. Notice how easy it is to turn the crank, and how high the voltage gets. A resistor in the pivot stand changes the scale to 10V, so double the voltage shown on the meter.

Set the switcher to the right position and turn the crank clockwise. The crank runs the melody IC, two LEDs, and motor. Notice how much harder it is to turn the crank now, and how the voltage doesn't get as high.

The crank is easier to turn when devices that need lots of electric current do not load it down. It is like you trying to throw rocks - you can throw small rocks much farther than you can throw heavy ones.

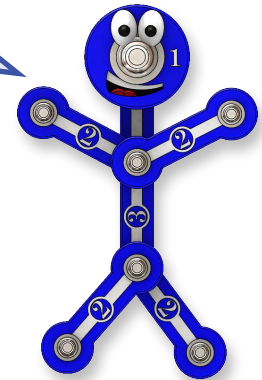

PROJECT 120 • Slow In Flash Out

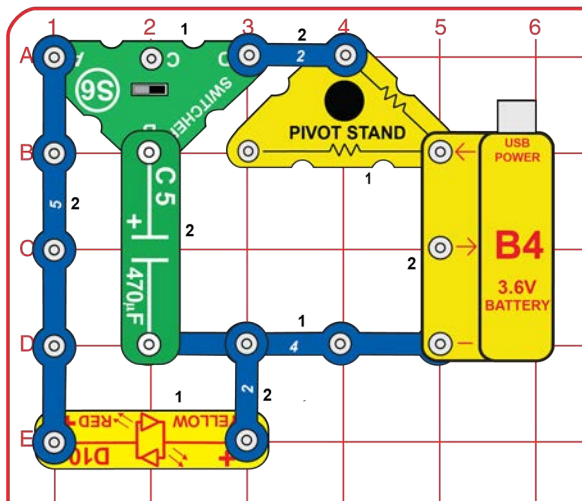

The electrons slowly trickle into the 470mF capacitor (C5) through a 10KW resistor (in the pivot stand) when the switcher (S6) is in the right position. If you wait and let the capacitor charge up it will flash nicely when you switch to the left. If you are not patient, and switch back too quickly your flash will be weak.

See project 3 if you need to recharge the battery (B4).

Patience is its own reward. If you just wait a little while, you get a brighter flash. If you rush your flash will be weak.

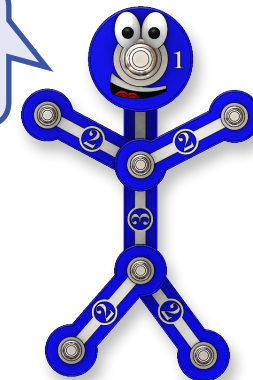

PROJECT 121 • Filling Station

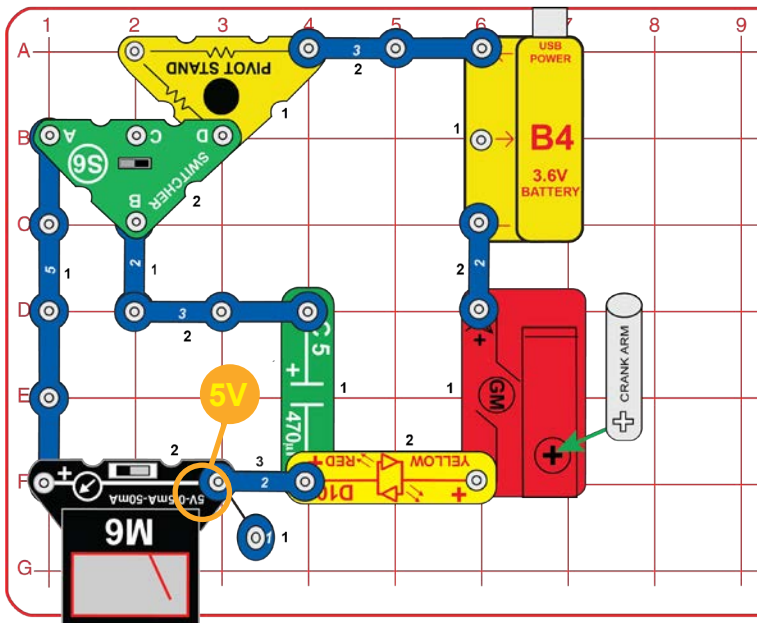

The 470mF capacitor (C5) is a storage device, so it would be nice to know when it is filled to capacity. With the switcher (S6) in the right position, turn the crank arm until the LED (D10) no longer produces light. When the capacitor is fully charged, the current is blocked and the light cannot turn on.

Flip the switcher to the left to show the voltage across the capacitor, but at the same time it will use current to move the meter and the charge will drop as you read it.

See project 3 if you need to recharge the battery (B4).

Did you ever wonder how long capacitor C5 could hold its charge? Try filling it up and waiting a while before taking a reading.



PROJECT 122 • Gas Pedal

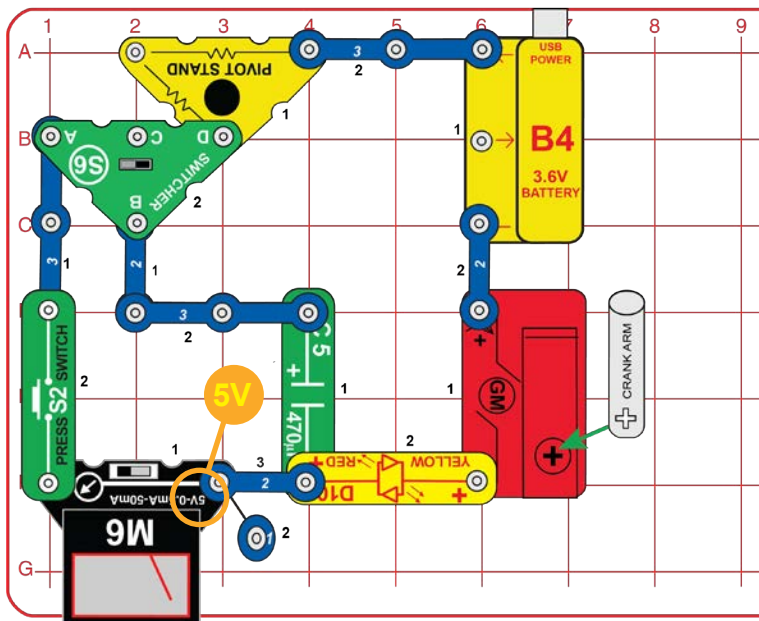

Modify the circuit to include the press switch (S2), as shown. With the switcher (S6) in the right position, turn the crank arm until the LED (D10) no longer produces light. When the capacitor is fully charged, the current is blocked and the light cannot turn on.

Flip the switcher to the left and notice that the meter does not move. The press switch is open and stops current from flowing until it is pressed, just like a gas pedal stops gasoline from flowing when the car is stopped.

Press S2 on and off a few times to send current to the meter.

I sure would not get very far if my electric car used a capacitor to store energy. I guess this is why they all use batteries and carry a gas driven charger to charge the batteries up when they get low.



PROJECT 123 • Volt Meter

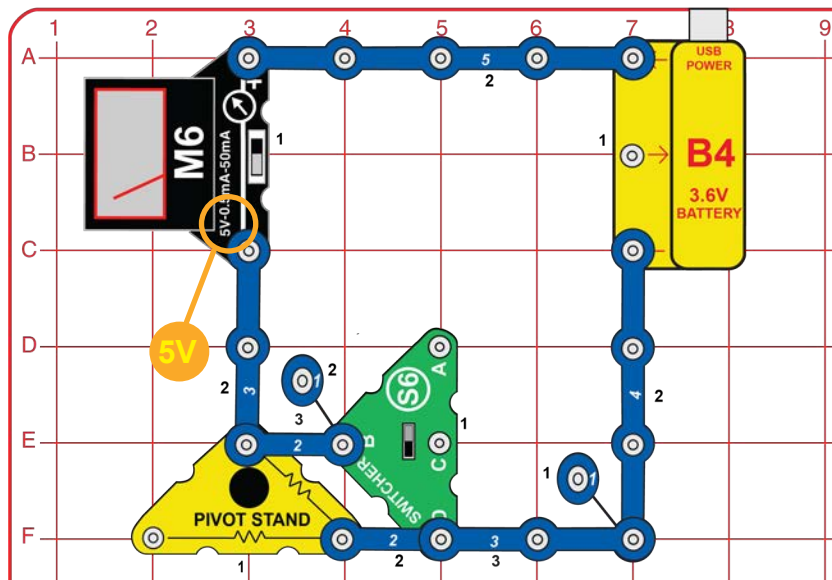

To make a voltage measurement, the meter (M6) is set to 5V and connected in parallel between the two points where the measurement is to be made. Since the voltmeter is in parallel and has a high resistance, very low current flows through it.

To measure the voltage of the battery (B4), set the switcher (S6) to the bottom position. Look at the scale and read the voltage, it should be over 3 volts. If the voltage is less than 3 volts, you need to charge the battery.

You can change the meter scale from 5V to 10V by adding a 10KΩ resistor in the pivot stand in series with the meter. Set the switcher to the top or middle position. The meter pointer drops to a lower position since each segment now equals 2V.

See project 3 if you need to recharge the battery (B4).

PROJECT 124 • Anemometer

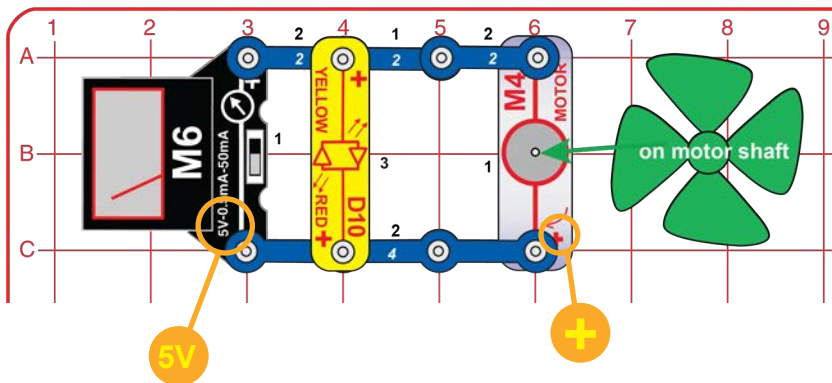

The energy in the moving wind can be used to generate electricity. An anemometer is a device used for measuring wind speed, and is one instrument used in a weather station. The term comes from the Greek word anemos, meaning wind. Leon Battista Alberti invented the anemometer.

Set the meter (M6) to the 5V setting. Slowly blow on the fan and notice the reading on the meter. The meter measures the voltage generated by the spinning shaft on the motor. The faster the shaft spins, the greater voltage generated. See how fast the fan must spin to light the LED.



Wind speed is important for wind energy. Wind turbines need a constant, average wind speed of about 14 miles per hour before the wind turbines can generate electricity.

PROJECT 125 • Capacitor Charging

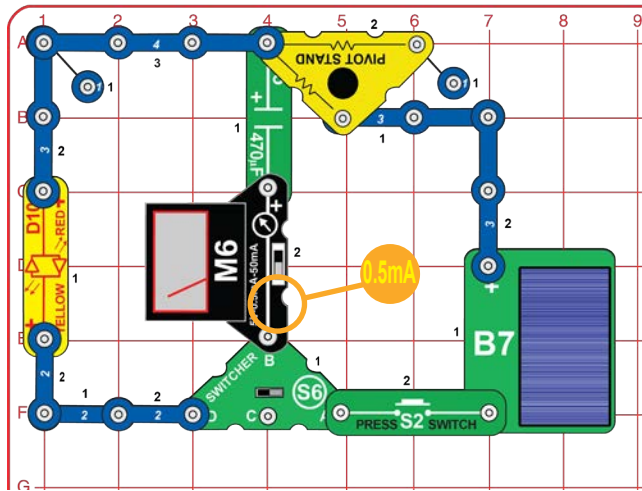

Build the circuit shown. Set the meter (M6) to the 0.5mA setting. Set the switcher (S6) to the right position, place the solar cell (B7) in sunlight or near an incandescent lamp, and push the press switch (S2). The solar cell slowly charges up the 470µF capacitor (C5), and the meter shows the current.

Set the switcher to the left position to discharge the capacitor, making the LED (D10) flash.

Set S6 back to the right, push S2 to see the current, and then set S6 back to the left to see the flash.

See project 3 if you need to recharge the battery (B4).

If you don't have a suitable light source, you can use the battery (B4) in place of the solar cell.



PROJECT 126 • Current Summer

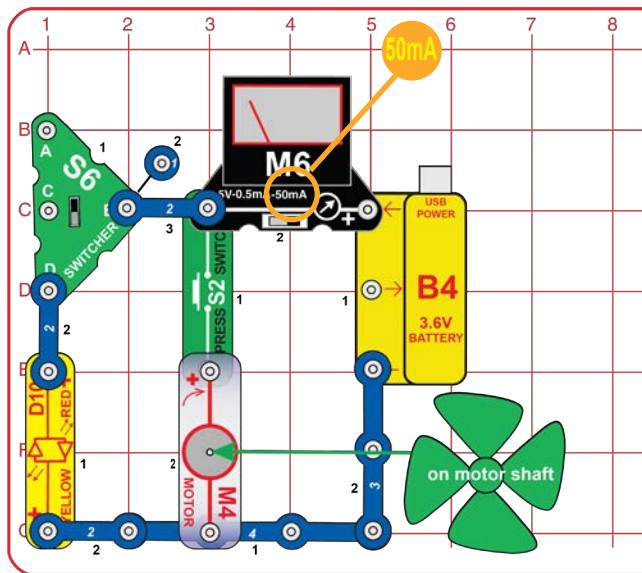

Build the circuit and set the meter (M6) to the 50mA setting and the switcher (S6) to the top position. Set the switcher to the bottom position to measure the current through the LED (D10), push the press switch (S2) to measure the current through the motor (M4), or do both to measure the combined current.

The current from the battery will go through the LED, the motor, or both, depending on which switches (S2 and S6) are on. If you add up the individual currents you measured for the LED and motor, they should add up to the current you measured for both. (Your result may be a little different, because M6 is a simple meter with low accuracy.)



PROJECT 127 More Current Summing

Replace the red/yellow LED (D10, "+" to top) with the color LED (D8) or the melody IC (U32, "+" to top), or place one of them directly over the red/yellow LED (on level 3). See how the current changes on the meter.

PROJECT 128 • Summing Voltage

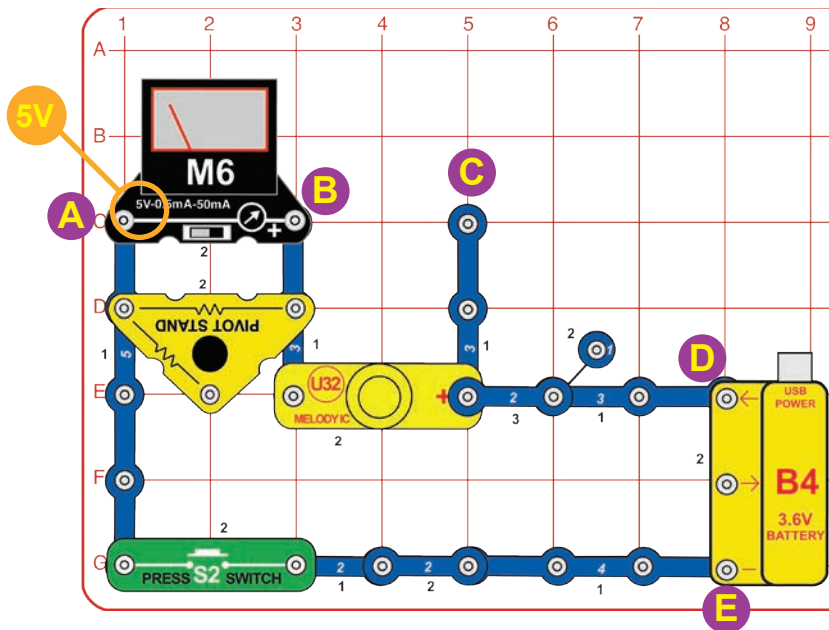

Build the circuit and place the wind fan on the motor (M4). Set the meter (M6) to the 5V setting. Push the press switch (S2); the meter measures the voltage across a resistor in the pivot stand. The measured voltage varies a little as the sound changes.

Now move the meter so it is across points B & C, so it measures the voltage across the melody IC (U32).

Now move the meter so it is across points D & E, so it measures the voltage from the battery (B4).

Compare the voltage across the battery to the sum of the voltages across the pivot stand and melody IC.

See project 3 if you need to recharge the battery (B4).

The voltage you measured across the battery should equal the sum of the voltages across the pivot stand and melody IC. (Your result may be a little different, because M6 is a simple meter with low accuracy.) This is because the voltage produced by the battery is the same as the voltages across all of the devices using it. There are also voltage drops across the snap wires and the press switch, but those are tiny and can be ignored.

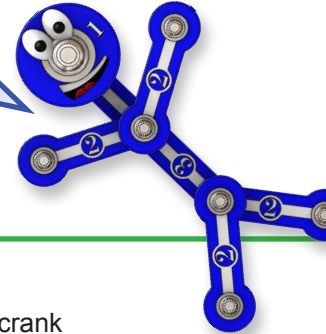

PROJECT 129 • Charging Currents

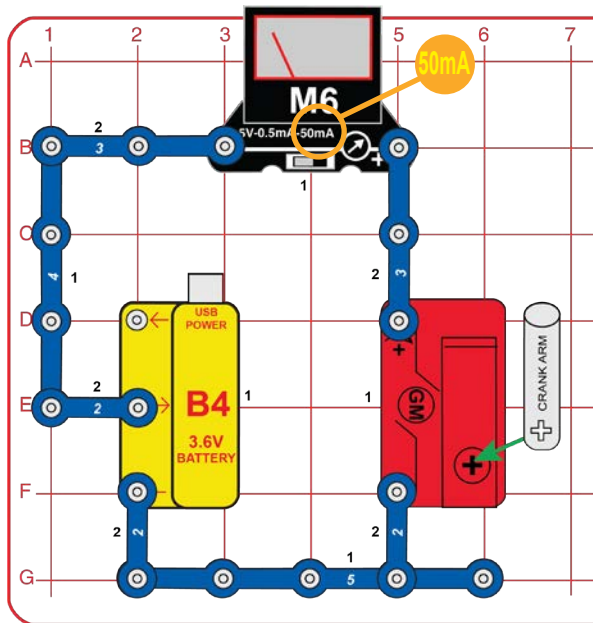

Build the circuit and set the meter (M6) to the 50mA setting. Turn the crank arm on the geared motor (GM) clockwise to charge the battery (B4), the meter measures the current. The battery will be more difficult to charge when it is near full charge.

Replace the geared motor with the motor (M4, "+" on bottom) and wind fan. Blow hard on the fan to charge the battery, and compare the charge current to that from the hand crank. Use either the 0.5mA or 50mA setting on the meter.

Now replace the motor and fan with the solar cell (B7). Place the solar cell in sunlight or near an incandescent light bulb, and compare the charge current to that from the hand crank and fan. Use either the 0.5mA or 50mA setting on the meter.

The hand crank should charge the battery a lot faster than the fan or solar cell, as shown by the charging currents you measure on the meter. However turning the crank arm takes a lot of effort from you, so it is much easier to charge the battery using wind or solar power.



PROJECT 130 • Big Resistance

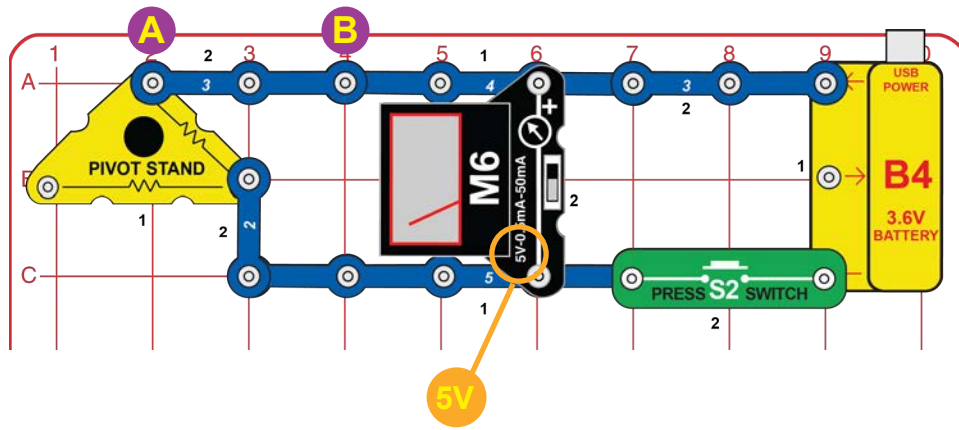

Set the meter (M6) to the 5V setting and push the press switch (S2). Read the voltage on the meter.

Next, replace the 3-snap wire across points A & B with the meter (“+” on right), and set the meter to the 0.5mA setting. Push the press switch and read the current on the meter.

Calculate the resistance using Ohm’s Law:

$$\text{Resistance} = \frac{\text{Voltage}}{\text{Current}}$$

See project 3 if you need to recharge the battery (B4).

These snaps on the pivot stand have an internal resistance of about 10,000 ohms, but your measurements will vary because the M6 meter is a simple meter with limited accuracy.



PROJECT 131 • Little Resistance

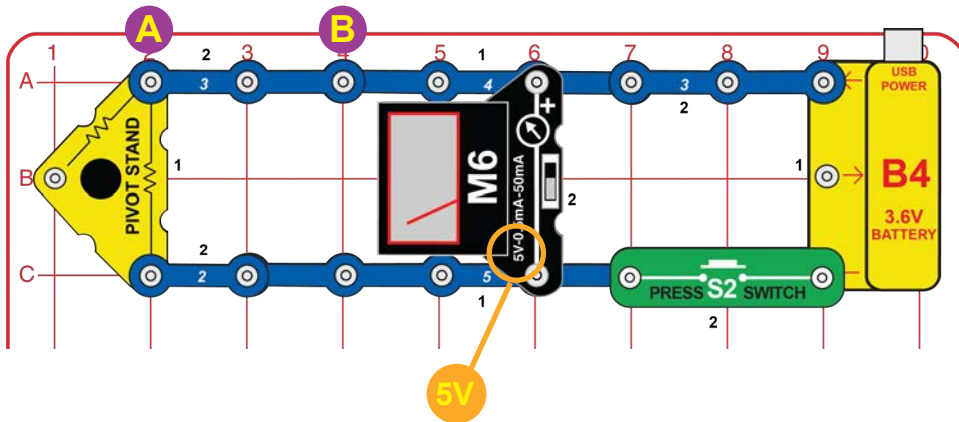

Modify the preceding circuit to be this one, which connects to a different resistor in the pivot stand. Set the meter (M6) to the 5V setting and push the press switch (S2). Read the voltage on the meter.

Next, replace the 3-snap wire across points A & B with the meter (“+” on right), and set the meter to the 50mA setting. Push the press switch and read the current on the meter.

Calculate the resistance using Ohm’s Law:

$$\text{Resistance} = \frac{\text{Voltage}}{\text{Current}}$$

These snaps on the pivot stand have an internal resistance of about 50 ohms, but your measurements will vary because the M6 meter is a simple meter with limited accuracy.



PROJECT 132 • Slow Charge

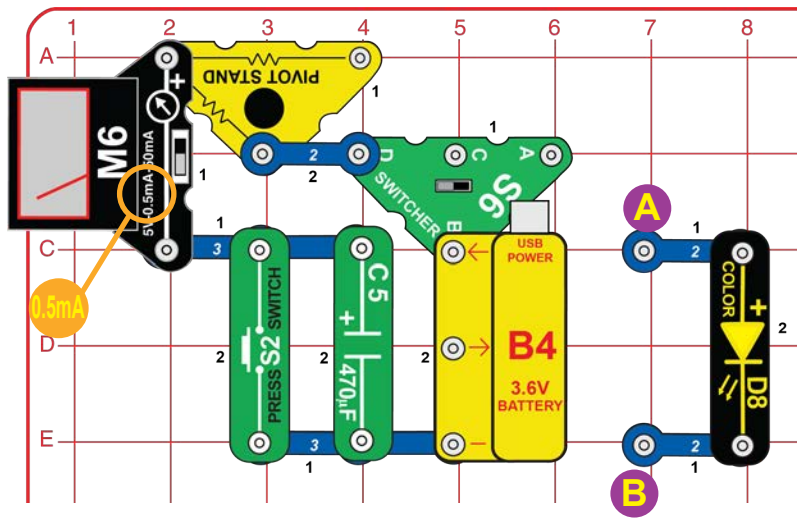

Set the meter (M6) to the 0.5mA setting, and set the switcher (S6) to the left position. Watch the current on the meter as the 470mF capacitor (C5) slowly charges up. Once C5 is near full charge you can push the press switch (S2) to instantly discharge the capacitor and restart the charging process.

Once C5 is near full charge remove it and connect it across points A & B. The color LED (D8) lights for a moment as C5 discharges through it. Return C5 to the main circuit to re-charge it.

See project 3 if you need to recharge the battery (B4).

A high resistance in the pivot stand is used here to charge the 470mF capacitor at a slow rate so you can watch it charge up. The capacitor is like a mini battery, which you can move to the LED and light it for a moment.



PROJECT 133 • Funky Beeper

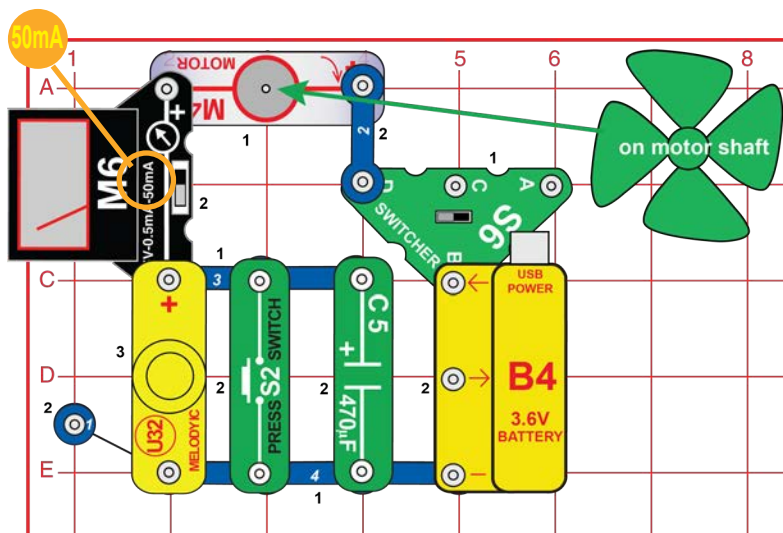

Set the meter (M6) to the 50mA setting, and set the switcher (S6) to the left position. You should hear a beeping sound from the melody IC (U32) as the meter measures the current. Spin the fan in either direction with your finger to change the sound. Push the press switch (S2) to spin the fan.

OTHER SNAP CIRCUITS® PRODUCTS!

Contact Elenco® to find out where you can purchase these products.

Snap Circuits® Jr.



Model SC-100

Build over **100** projects

Including:

- Flying saucer
- Spin draw
- Sound activated switch
- Alarm circuit

Contains over **30** parts

Including:

- Photoresistor
- Motor
- Music IC
- Space War IC

Snap Circuits® STEM



Model SC-STEM

Build over **85** projects

Including:

- Lots of Lights
- Flying Saucer
- Electronic Playground
- Static Electricity

Contains over **40** parts

Including:

- Compass
- Electromagnet
- Relay
- Magnet

Snap Circuits®

Model SC-300

Build over **300** projects

Including:

- AM radio
- Radio announcer
- Lie detector
- Burglar alarm

Contains over **60** parts

Including:

- Two transistors
- Microphone
- Power amplifier IC
- Variable capacitor

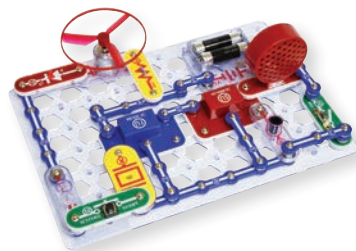

Snap Circuits® BRIC: Structures

Model SC-BRIC1

Build over **25** projects

Including:

- Start Circuit
- 5 Lights and a Melody
- 4 Lights and Clicking
- Light Post

Contains over **200** parts

Including:

- Melody IC
- Brick Remover Tool
- 3D Snap
- Fiber Optic Tree



Snap Circuits® Light

Model SCL-175

Build over **175** projects

Including:

- Color Light
- White Light
- Red Light
- Light Show

Contains over **55** parts

Including:

- Phototransistor
- Adjustable Resistor
- Slide Switch
- Strobe IC

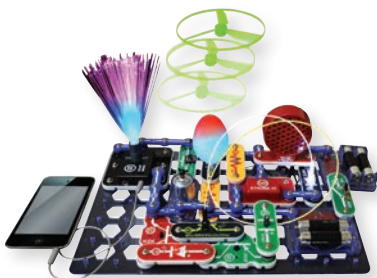

Smart-phone shown not included.

Snap Circuits® Arcade

Model SCA-200

Build over **200** projects

Including:

- Lots of Lights
- Flying Saucer
- Electronic Playground

Contains over **30** parts

Including:

- Programmable Fan
- Alarm IC
- LED Display & Microcontroller
- Speaker



